



LINETRAXX® CTUB100 series

AC/DC sensitive measuring current transformers (type B)

Intended use

The AC/DC sensitive measuring current transformers (type B) of the CTUB100 series convert system leakage and fault currents into an evaluable measurement signal. The devices are suitable for detecting fault currents with smooth DC components. They consist of a CTBC... measuring current transformer core and a CTUB10... electronic module, which can be combined to suit the application. The measuring current transformers can be used in DC, AC, and 3(N)AC systems. The measurement signal is evaluated using devices of the RCMA4..., RCMS4..., RCMB4... or MRCD4... series, respectively EDS441-LAB series, to which the measuring current transformers are connected. Any other use than that described in this manual is regarded as improper.



General safety instructions

Part of the device documentation in addition to this manual is the enclosed "Important safety instructions for Bender products".

Installation, connection and commissioning are to be carried out by electrically skilled persons only!

It is essential to follow the existing safety instructions.



DANGER! indicates a high risk of danger that will result in death or serious injury if not avoided.



CAUTION! indicates a low-level risk that can result in minor or moderate injury or damage to property if not avoided.



This symbol refers to information that is designed to help you make the best use of the product.

Device features

- Multicolour LED for operation, fault and status messages
- Electronic module can be exchanged without mechanical separation of the primary conductors
- Extension/retrofitting or modification of functionalities possible in case of changed monitoring requirements
- Insensitive to load currents due to full magnetic shield, can be used for high short-term system-related load currents (for CTBC...P only).
- Monitoring of the connection to the measuring current transformer

Overview: Possible combinations of evaluator, electronic module and measuring current transformer core

Electronic module	Evaluator	Meas. CT core	Connecting cable	Supply voltage
CTUB101	RCMA420	CTBC20(P)...60(P)	CTX... (6 wires)	DC ±12 V The evaluator supplies the measuring current transformer.
	RCMA423	CTBC20(P)...210(P)		DC ±12 V External power supply unit AN420
	RCMS460/490*	CTBC20(P)...210(P)	CTX... (5/6 wires)	
CTUB102, CTUB105	RCMS410/425 /460/490	CTBC20(P)...210(P)	CTXS... (4 wires)	DC 24 V External power supply unit required for measuring current transformer.
CTUB102 (Replaces CTUB104 in EDS441-LAB applications)	EDS441-LAB	CTBC20(P)...60(P)		

* Only recommended for retrofit if an AN420 power supply unit is already available. In this case, if the ready-made connecting cable CTX... is used, the green plugs of the connecting cable (on the evaluator side) must be removed.

Afterwards, the individual conductors must be crimped and connected to the RCMS460/490 or the AN420. In this case, the conductor "T" is not used

Dimension diagrams

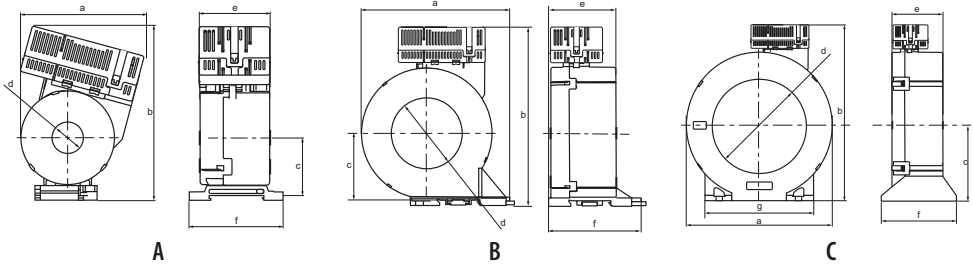

Dimensions (mm), tolerance: ±0.5 mm

	Type	a	b	c	d	e	f	g
A	CTUB...-CTBC20(P)	75	83	37	∅ 20	46	60.5	—
	CTUB...-CTBC35(P)	97	130	47	∅ 35	46	61	—
B	CTUB...-CTBC60(P)	126	151	57	∅ 60	56	78	—
C	CTUB...-CTBC120(P)	188	225	96	∅ 120	65	96	139
	CTUB...-CTBC210(P)	302	339	153	∅ 210	67	113	277
D	CTUB...	74	44	30	32	4.6	—	—

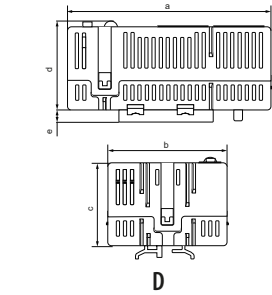

Mountings (mm)

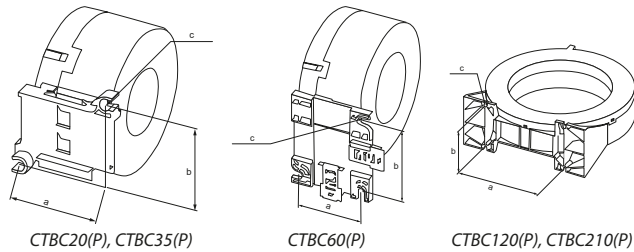

Type	a	b	c
CTBC20(P)	31.4	49	2 x ∅ 5.5
CTBC35(P)	49.8	49	2 x ∅ 5.5
CTBC60(P)	56	66	3 x ∅ 6.5
CTBC120(P)	103	81	4 x ∅ 6.5
CTBC210(P)	180	98	4 x ∅ 6.5

Assembly

Slide the electronic module onto the plug contacts of the measuring current transformer.

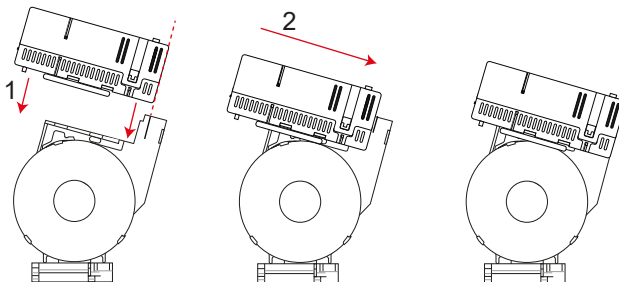

i Avoid repeated plugging and unplugging of the electronics (10 plugging cycles).

Device view

No.	CTUB101	CTUB102	CTUB105	Note												
1	Terminal	S1 (K)		Connection measuring current transformer core												
2		S2 (I)														
3		–		Not in use												
4		–														
5		+12 V	24 V	24 V	Supply voltage U_S											
6		GND														
7		–12 V	–	–												
8		T	–	–	Connection external test from RCMA...											
9	Test button T			a) Offset calibration * b) Internal functional test **												
10	Combined LED			LED lights green normal operation LED flashes red device error ***												
11	Potentiometer for adjusting the measuring range	Potentiometer for adjusting the measuring range	Potentiometer without function	<table border="1"> <thead> <tr> <th>CTUB101/102</th> <th>Response value evaluator</th> <th>Measuring range peak</th> </tr> </thead> <tbody> <tr> <td></td> <td>$I_{\Delta n} \leq 0.1 \text{ A}$</td> <td>0...900 mA</td> </tr> <tr> <td></td> <td>$0.1 \text{ A} < I_{\Delta n} \leq 0.5 \text{ A}$</td> <td>0...3.5 A</td> </tr> <tr> <td></td> <td>$I_{\Delta n} > 0.5 \text{ A}$</td> <td>0...20 A</td> </tr> </tbody> </table> <p>RCM applications: Select the measuring range according to the response value $I_{\Delta n}$ set on the evaluator. If a larger measuring range is selected, the accuracy will decrease. CTUB102 with EDS441-LAB: Location current EDS441-LAB max. 25 mA. Adjust the measuring range on the measuring current transformer to this range. CTUB105: Measuring range 3 is fixed and cannot be changed.</p>	CTUB101/102	Response value evaluator	Measuring range peak		$I_{\Delta n} \leq 0.1 \text{ A}$	0...900 mA		$0.1 \text{ A} < I_{\Delta n} \leq 0.5 \text{ A}$	0...3.5 A		$I_{\Delta n} > 0.5 \text{ A}$	0...20 A
CTUB101/102	Response value evaluator	Measuring range peak														
	$I_{\Delta n} \leq 0.1 \text{ A}$	0...900 mA														
	$0.1 \text{ A} < I_{\Delta n} \leq 0.5 \text{ A}$	0...3.5 A														
	$I_{\Delta n} > 0.5 \text{ A}$	0...20 A														

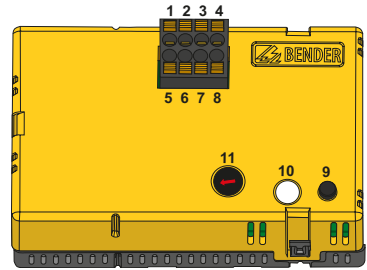
*** Test button T: Offset calibration**

i For measuring current transformer cores with an **internal diameter $\geq 120 \text{ mm}$** , an **offset calibration** should always be carried out before the first commissioning. Note that during the offset calibration the system is switched off and no current flows through the measuring current transformer.

Offset calibration sequence

	Action	LED
1	Install the measuring current transformer in the system, assemble the electronic module and the measuring current transformer core, U_S disconnected	Off
2	Press and hold the "T" button	Off

	Action	LED
3a	Press and hold "T", supply the electronic module with supply voltage U_S	Lights red permanently (not ready for operation)
3b		Flashes red slowly after approx. 2 s (ready for calibration)
3c		Flashes red quickly after a total of 5 s (calibration mode)
4	Start calibration: release "T" when the LED flashes red quickly	Flashes red quickly
5	Calibration in progress	Flashes red quickly
6a	Calibration successful, values are accepted	Lights green permanently
6b	Calibration not successful. Calibration value is not accepted. The device is in an error state. Either carry out another offset measurement or clear the error by switching the device off and on again.	Flashes red slowly

**** Test button T:
Internal functional test**

Press test button "T" for 5... 10 s.
When the LED flashes green quickly, release the button.
Function test begins, varying measured values are output. Their amplitude depends on the setting of the detent potentiometer.

After completion of the function test, the LED lights up green.

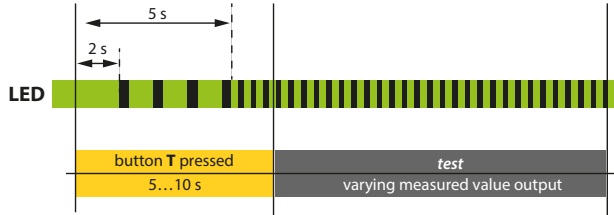

***** Device error**

- i** *CTUB101/102: In the event of a fault, a high DC residual current (equal to the respective full scale value) is also output so that the fault is visible on the evaluator.*
- CTUB105: A fixed residual current is output (see technical data).*

Possible cause of error	Action
Connection between CTUB... and CTBC... is not correct	Check connection or disconnect CTUB... and CTBC... and reconnect
Error after offset calibration (possibly system not switched off and therefore DC residual current too high)	Either carry out an offset calibration again or clear the error by switching the device off and on again. either carry out an offset calibration again or clear the error by switching the device off and on again
Supply voltage U_S incorrect ($\pm 12 V$ or $24 V$)	Apply correct supply voltage U_S

Possible cause of error	Action
Detent potentiometer (11) is not correctly engaged in one position, but is between two positions	Engage the detent potentiometer correctly
Detent potentiometer is not set correctly, evaluators display error E.01 (CT error)	Set correct response value on detent potentiometer

If the fault cannot be eliminated, contact Bender Service.

Wiring

- DANGER** of electrocution due to electric shock!
Touching live parts of the system carries the risk of:
 - An electric shock
 - Damage to the electrical installation
 - Destruction of the device**Before installing and connecting the device, make sure that the installation has been de-energised.** Observe the rules for working on electrical installations. Observe the information on rated voltage and supply voltage specified in the technical data!

- i** Application in railway vehicles/
DIN EN 45545-2:2016!
If the horizontal or vertical distance to adjacent components which do not meet the requirements in table 2 of DIN EN 45545-2 is less than 20 mm or less than 200 mm respectively, they are to be regarded as grouped. Refer to DIN EN 45545-2 chapter 4.3 Grouping rules.
- i** The wires can be routed in any direction.

Connect the device according to the wiring diagram. Please observe the technical data.

Wiring diagram

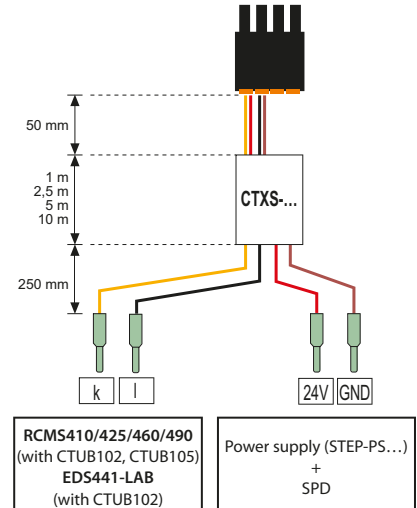
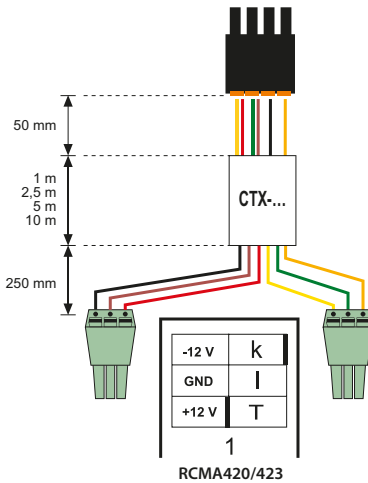
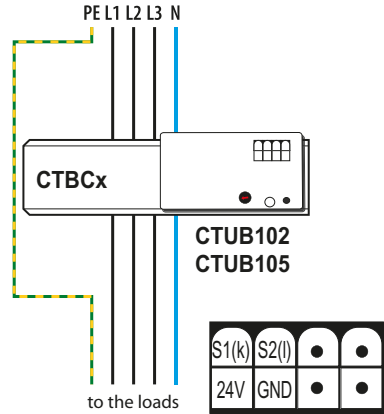
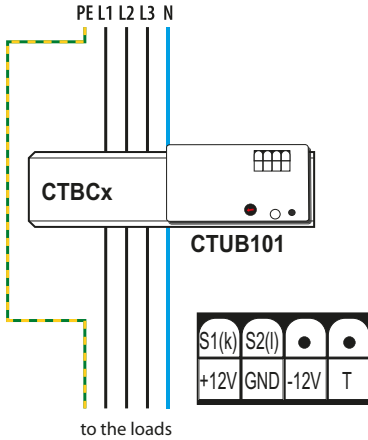

The use of a type 2 surge protection device (SPD) is mandatory due to possible impulse voltages and in order to comply with normative requirements. The surge protection device must be connected upstream of the power supply unit on the supply side.

Features of the surge protection device:

- Nominal discharge current I_n (8/20 μ s): 20 kA
- Response time: 25 ns
- two-stage: 1 varistor + 1 spark gap

Alternatively, the power supply unit must be connected to a CAT II supply without a surge protection device.



CAUTION!

When using several CTUB100 measuring current transformers, the power supply (24V, GND) must not be daisy-chained from current transformer to current transformer but should be star-shaped (e.g. using a potential distributor).



Test current

The EDS441-LAB operates exclusively with a test current of max. 25 mA. Adjust the measuring range on the measuring current transformer to this range.

Installation instructions measuring current transformer



CAUTION! Existing protective conductors and low-resistance conductor loops must not be routed through the measuring current transformer! Otherwise, high currents could be induced into the conductor loop due to the AC/DC sensitive measuring technology used.



CAUTION! The connecting cable (supply, secondary connection etc.) must not be routed directly past the current transformer core, otherwise interference pulses may occur.



CAUTION! The measuring current transformer must be connected to the corresponding evaluator before the first use and before commissioning of the monitored installation.



Do not route any shielded cables through the measuring current transformer.

Pay attention to the following:

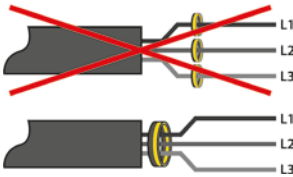

All current-carrying cables must be routed through the measuring current transformer.

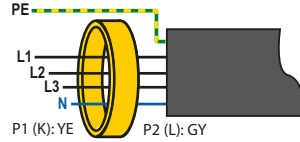

Never route an existing protective conductor through the measuring current transformer.

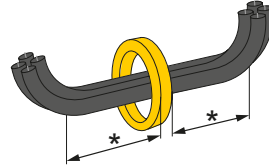

The primary conductors may only be bent from the specified minimum distance. The minimum bending radius specified by the manufacturers for the conductors used must be observed.

* Distance to 90° angle = 2 x outer diameter.

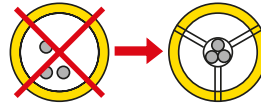

The cables must be aligned with the centre of the measuring current transformer.

Technical data

Insulation coordination acc. to IEC 60664-1/IEC 60664-3

Definitions

Measuring circuit (IC1)	Prim. conductors routed through the CT
Secondary (IC2)	Connections terminal block
Rated voltage.....	800 V
Overvoltage category	III
Area of application	≤ 2000 m AMSL
Rated impulse voltage (IC1/IC2)	8 kV
Rated insulation voltage (reinforced insulation; IC1/IC2)	800 V
Pollution degree	2

Supply voltage

CTUB101	
Description	+12 V, GND, -12 V
Supply voltage U_s	DC ±12 V
Operating range of U_s	±2 %

Ripple U_s	≤ 1 %
Power consumption	≤ 2.5 W
CTUB102 and CTUB105	
Description	24 V, GND
Supply voltage U_s	DC 24 V
Operating range of U_s	±20 %
Ripple U_s	≤ 1 %
Power consumption	≤ 2.5 W
Inrush current	1 A for 1 ms

Measuring circuit

Internal diameter measuring CT	see dimension diagrams
Rated current I	RCM application / MRCD application
CTBC20 at $I_{\Delta n} \geq 30$ mA	63 A / 40 A
CTBC20 at $I_{\Delta n} \geq 300$ mA	80 A / 63 A
CTBC20P	80 A / 80 A
CTBC35 at $I_{\Delta n} \geq 30$ mA	125 A / 80 A
CTBC35 at $I_{\Delta n} \geq 300$ mA	160 A / 125 A

CTBC35P	160 A / 160 A
CTBC60 at $I_{\Delta n} \geq 30$ mA	200 A / 160 A
CTBC60 at $I_{\Delta n} \geq 300$ mA	400 A / 250 A
CTBC60P	400 A / 320 A
CTBC120 at $I_{\Delta n} \geq 100$ mA	400 A / 330 A
CTBC120P at $I_{\Delta n} \geq 100$ mA	630 A / 630 A
CTBC210 at $I_{\Delta n} \geq 300$ mA	630 A / 630 A
CTBC210P at $I_{\Delta n} \geq 100$ mA	630 A / 630 A
CTBC210P at $I_{\Delta n} \geq 300$ mA	1000 A / 1000 A

Measurement accuracy	± 1 % of full scale value
Test winding	yes
Rated continuous thermal current ¹⁾ I_{cth}	125 A
at UL applications	30 A
Rated short-time thermal current ¹⁾ I_{th}	2.4 kA/1 s
Rated dynamic current ¹⁾ I_{dyn}	6 kA/40 ms

i Residual current > 6 kA: Device defect CTUB1... , message via LED
There is no danger of fire or electric shock.

Possible response values (set on the evaluator)

CTBC20, CTBC20P	10 mA... 500 mA
CTBC35, CTBC35P, CTBC60, CTBC60P	30 mA... 10 A
CTBC120, CTBC120P, CTBC210P	100 mA... 10 A
CTBC210	300 mA... 10 A

Measuring ranges CTUB101, CTUB102

Measuring range 1 ($I_{\Delta n} \leq 0.1$ A)	0... 900 mA (peak)
Measuring range 2 (0.1 A < $I_{\Delta n} \leq 0.5$ A)	0... 3.5 A (peak)
Measuring range 3 ($I_{\Delta n} > 0.5$ A)	0... 20 A (peak)

Measuring range CTUB105

Measuring 3 ($I_{\Delta n} > 0.5$ A)	0... 20 A (peak)
---	------------------

Indication

Multicolour LED	See pages 3/4
-----------------------	---------------

Output

Name	S1 (k), S2 (l)
Scaling	400 mV/1 A
Max. voltage	± 10 V
Output device error	
CTUB101, 102	Max. full scale value
CTUB105	8 A
Max. connector length	10 m
Output resistance	172 Ω

Input

Name	T (for CTUB101 only)
Current load	< 300 mA

Environment/EMC

EMC	IEC 62020-1
Operating temperature	-25... 70 °C

Classification of climatic conditions acc. to IEC 60721

Stationary use (IEC 60721-3-3)	3K22
Transport (IEC 60721-3-2)	2K11
Long-term storage (IEC 60721-3-1)	1K22

Classification of mechanical conditions acc. to IEC 60721

Stationary use (IEC 60721-3-3)	3M11
Transport (IEC 60721-3-2)	2M4
Long-term storage (IEC 60721-3-1)	1M12

Connection

Max. connection length	10 m
------------------------------	------

Connecting cables are optionally available.
Use 60/75 °C copper lines only.

Terminal block

Manufacturer	Phoenix Contact
Type	DFMC 1.5/4-ST-3.5 BK

The connection conditions of the manufacturer apply.

Connection properties

rigid	0.2... 1.5 mm ² (AWG 24... 16)
flexible	0.2... 1.5 mm ²
with ferrule	0.25... 0.75 mm ²

Mounting CTBC...

Screw type

CTBC20... 60(P)	DIN EN ISO 7045 - M5
CTBC120... 210(P)	DIN EN ISO 7045 - M6

Washer type

CTBC20... 60(P)	DIN EN ISO 7089/7090 - 5
CTBC120... 210(P)	DIN EN ISO 7089/7090 - 6

Tightening torque

CTBC20... 35 (P)	0.6 Nm
CTBC60... 210(P)	1 Nm

Other

Operating mode	Continuous operation
Mounting	Any position
Degree of protection, built-in components (DIN EN 60529)	IP40
Degree of protection, terminals (DIN EN 60529)	IP20
Flammability class	UL94 V-0
Software	D591
Weight	

CTUB10x-CTBC20	≤ 230 g
CTUB10x-CTBC20P	≤ 290 g
CTUB10x-CTBC35	≤ 310 g
CTUB10x-CTBC35P	≤ 390 g
CTUB10x-CTBC60	≤ 530 g
CTUB10x-CTBC60P	≤ 690 g
CTUB10x-CTBC120	≤ 1460 g
CTUB10x-CTBC120P	≤ 1820 g
CTUB10x-CTBC210	≤ 4290 g
CTUB10x-CTBC210P	≤ 4940 g

The use of the power supply units listed at "Accessories" is recommended. The use of a surge protection device is mandatory for these power supply units.

Ordering details

U_s	ø CT	Shielding	Type	Art. No.	
Use with RCMA420/RCMA423					
DC ±12V	20 mm	–	CTUB101-CTBC20	B78120010	
		■	CTUB101-CTBC20P	B78120020	
	35 mm	–	CTUB101-CTBC35	B78120012	
		■	CTUB101-CTBC35P	B78120022	
	60 mm	–	CTUB101-CTBC60	B78120014	
		■	CTUB101-CTBC60P	B78120024	
	120 mm	–	CTUB101-CTBC120	B78120016	
		■	CTUB101-CTBC120P	B78120026	
	210 mm	–	CTUB101-CTBC210	B78120018	
		■	CTUB101-CTBC210P	B78120028	
	Use with RCMS410/RCMS425/ RCMS460/RCMS490				
	DC 24V	20 mm	–	CTUB102-CTBC20	B78120011
■			CTUB102-CTBC20P	B78120021	
35 mm		–	CTUB102-CTBC35	B78120013	
		■	CTUB102-CTBC35P	B78120023	
60 mm		–	CTUB102-CTBC60	B78120015	
		■	CTUB102-CTBC60P	B78120025	
120 mm		–	CTUB102-CTBC120	B78120017	
		■	CTUB102-CTBC120P	B78120027	
		■	CTUB105-CTBC120P	B78120041	
210 mm		–	CTUB102-CTBC210	B78120019	
		■	CTUB102-CTBC210P	B78120029	
Use with EDS441-LAB					
DC 24V	20 mm	■	CTUB102-CTBC20P	B78120021	
	35 mm	■	CTUB102-CTBC35P	B78120023	
	60 mm	■	CTUB102-CTBC60P	B78120025	

Connecting cables

Length (m)	Connection to	Type	Art. No.
1	RCMA42...	CTX-100	B98110080
2.5		CTX-250	B98110081
5		CTX-500	B98110082
10		CTX-1000	B98110083
1	RCMS4... EDS441-LAB	CTXS-100	B98110090
2.5		CTXS-250	B98110091
5		CTXS-500	B98110092
10		CTXS-1000	B98110093

Replacement parts

Measuring current transformer cores

ø CT	Type	Art. No.
20 mm	CTBC20	B98120001
	CTBC20P	B98120002
35 mm	CTBC35	B98120003
	CTBC35P	B98120004
60 mm	CTBC60	B98120005
	CTBC60P	B98120006
120 mm	CTBC120	B98120007
	CTBC120P	B98120020
210 mm	CTBC210	B98120008
	CTBC210P	B98120021

Electronic modules

U_s	Type	Art. No.
DC ±12V	CTUB101	B78120050
DC 24V	CTUB102	B78120051
DC 24V	CTUB105	B78120054

Required terminals or connecting cables are optionally available.

Standards

The measuring current transformers of the CTUB10x series comply with the requirements of the standard DIN EN 45545-2.

Accessories

Voltage supply DC 24 V for CTUB102 and CTUB105

Max. connected CTs	Type	Art. No.
4	STEP-PS/1 AC/24 DC/0.5	B94053110
14	STEP-PS/1 AC/24 DC/1.75	B94053111
34	STEP-PS/1 AC/24 DC/4.2	B94053112



Bender GmbH & Co. KG

Londorfer Straße 65
35305 Grünberg
Germany

Tel.: +49 6401 807-0
info@bender.de
www.bender.de

Alle Rechte vorbehalten.
Nachdruck und Vervielfältigung nur mit
Genehmigung des Herausgebers.

All rights reserved.
Reprinting and duplicating only with
permission of the publisher.



© Bender GmbH & Co. KG, Germany
Subject to change! The specified
standards take into account the edition
valid until 09/2024 unless otherwise
indicated.