

MONITOR

2
16

POWERSCOUT®

Monitoring and analysis
of your electrical system made easy

The new insulation fault location system EDS440:
Insulation fault location even more
efficient and reliable



Electric energy stores
remain a broad area of research

Page A
Practical Expertise

Bender system communication

The communication in a Bender system is available from a large number of different protocols and standards like IEC 61850, Modbus, Profibus, CANopen, etc. The Bender system is designed to be flexible and can be adapted to the specific requirements of the user. The Bender system is designed to be flexible and can be adapted to the specific requirements of the user. The Bender system is designed to be flexible and can be adapted to the specific requirements of the user.

In the Bender system, the Bender system is designed to be flexible and can be adapted to the specific requirements of the user. The Bender system is designed to be flexible and can be adapted to the specific requirements of the user.

NEW

Additional page **"Practical Expertise"** at the back of the booklet for collection!
Bender system communication

BENDER Group



Dear Readers,

In the last editorial, I went into the increasing digitalisation of our products, with Ethernet at the fieldbus level, web servers in measuring devices and virtual measuring points. Now, six months later, it gives me real pleasure to introduce the central point that brings everything together: POWERSCOUT®!

POWERSCOUT® is our new server-based software. I could also say cloud-based, but that has a lot of negative connotations in Germany. I'll say it up front: the cloud-based architecture has advantages, but if you are not convinced, you can also run POWERSCOUT® on your own server. As may best please you.

This is how POWERSCOUT® works: You install Bender devices or have a pre-installed system. You can collect all devices via a collector module. How? Simply connect them. Want to connect third-party devices as well? No problem. The collector pushes all the status data to a database. Completely automatically. Plug in the Ethernet cable and that's it. Central analysis software collects the data and presents it to you in an understandable form. How? Automatically. Where do you have to install your user-interface? Nowhere. You only need a web browser. That's all. Your electrical system is then your constant companion. POWERSCOUT® offers a range of different functions. You can configure your templates, your alarms and your reports yourself. It's easy. There are pre-configured widgets to make it even easier to get started. It is all intuitive using 'drag and drop'.

It is all so easy that you probably won't need the support we are offering via our local technical offices. Which is a shame, it would have been nice to have had a chat! Maybe we'll catch up anyway. Why don't you just give us a call?

Yours

Dirk Pieler
Managing Director

IMPRINT

Bender GmbH & Co. KG.
Londorfer Straße 65
35305 Gruenberg / Germany
Fon: +49 6401 807 - 0
Fax: +49 6401 807 - 259
E-Mail: info@bender.de
www.bender.de

Editorial staff: Marita Schwarz-Bierbach,
Anne Katrin Römer

Graphic & layout: Natascha Schäfer, www-designment.net

Copy-editing/text: Michaela Heck M.A., Textwerk

Photos: Bender Archiv, SIDesignment Archiv, Energiepark Mainz, www.siemens.com/presse, KIT, Karlsruher Institut für Technologie, Johnson Controls, SWI swissinfo.ch, Verbund AG, Universität Hohenheim – Eric Lichtenscheidt, Flughafen München: Werner Hennies, Tenowo, StreetScooter/Deutsche Post DHL Group, Schluchseewerk AG, Stefan Spychalski Hochschule Bochum, Al Sanabel Dubai, Multivac Fotolia: Cybrain, KurtKubik, skdesign, froxx, potowizard, concept w, brodehl, mario beauregard, shockfactor.de
123RF: kzenon
AdobeStock: Sergey Nivens

Print: Druckhaus Bechstein, Wetzlar



Electric energy stores remain a broad area of research

Page 04

Electro-mobility is not yet properly out of the starting blocks: we are still waiting for the big breakthrough. As things currently stand, there is no prospect of high-performance, cost-effective batteries which are suitable for everyday use ...



Insulation fault location up to maximum low-voltage limit

Page 26

Insulation monitoring device ISOMETER® iso1685DP for unearthed AC, AC/DC and DC power supplies (IT systems) up to 1000 VAC / 1500 VDC ...



MULTIVAC Specialist for Better Packaging

Page 45

MULTIVAC is one of the world's leading suppliers of packaging solutions: global market leader in thermoformers and manufacturer of an extensive range of traysealers, vacuum chamber machines ...

04 **Electric energy stores remain a broad area of research**

NEWSWORTHY

- 11 **Management changes** at Bender USA and Bender UK
- 12 **Working against the signs of the times:** Electrical safety in "old" medical installations

INNOVATIVE PRODUCTS

- 14 **POWERSCOUT®:** Monitoring and analysis of your electrical system made easy
- 16 **Insulation fault location even more efficient and reliable** with the new insulation fault location system EDS440
- 20 **The energy revolution needs storage**
- 23 **isoUG425, iso1685FR and isoNAV685-D:** Fast tripping and fast shutdown
- 26 **Insulation monitoring device ISOMETER® iso1685DP:** Insulation fault location up to maximum low-voltage limit

TECHNICAL APPLICATION

- 28 **Pumped-storage hydro power station Bad Säckingen:** High availability guaranteed
- 32 **Non-stop quality:** Tenowo, Hoftex at Reichenbach
- 35 **CO₂-free delivery:** Streetscooter delivers letters and parcels electrically
- 38 **Sporty electro-mobility with solar energy:** Bender technology in solar cars, not just for Down Under

BENDER INHOUSE

- 41 **Bender in the data portal wscaduniverse.com:** From the device library to the circuit diagram and onto the mounting plate

AGENTS CORNER

- 42 **AL SANABEL TECHNOLOGIES LLC:** Proud representative of Bender GmbH & Co. KG in Dubai, Qatar and Pakistan

CUSTOMER PORTRAIT

- 45 **MULTIVAC – specialist for Better Packaging:** Packages protect goods and keep their quality
- 48 **Seminar announcement +++ Specialist conference 11/2016:** Electrical systems at airports
- 49 **EXHIBITIONS 2016/2017**
- 50 **INTERVIEW** with **Peter Eckert**, Market Segment Manager Critical Infrastructure at Bender

NEW 52 **PRACTICAL EXPERTISE:** Bender system communication



FEATURE

Electric Energy stores

... remain a broad area of research

Electro-mobility is not yet properly out of the starting blocks: we are still waiting for the big breakthrough. As things currently stand, there is no prospect of high-performance, cost-effective batteries which are suitable for everyday use. Large, international automotive companies (inc. Tesla) are planning massive battery factories costing millions to finally resolve this dilemma.



But this is directly linked to the question as to how things are looking with the various technological approaches and solutions for electrical energy storage in general, especially as electro-mobility represents just one aspect of the broad range of applications.

In terms of practical application, disposable and rechargeable batteries and pump storage power stations are way out in front, with hydrogen, flywheel energy storage, accumulator power plants, magnetic storage and condensers some way behind as further electrical energy storage options. A more recent addition to the ranks is hybrid storage, which is said to combine the complementary technical properties of batteries and condensers.

As a general rule, the broad field of research and development into the wide range of battery technologies is ever changing and new research approaches are constantly being presented, most of which have the real test of their practical implementation and evidence of their usability in front of them.

Device batteries dominant

With such a wide range of **device batteries** available, experts make a distinction between primary and secondary systems. Rechargeable batteries fall into the category of secondary batteries, where the chemical energy consumed is restored by the charging process. This process can be repeated up to a thousand times. By contrast, primary batteries can be discharged only once. However, the energy density of primary batteries is normally significantly greater than that of secondary batteries. However, their behaviour is exactly reversed when it comes to robustness. One exception to this rule is lithium ion batteries, which, in relative terms, store the most energy and can hold it for lots of charges.

One of the significant differences in terms of the functionality of device batteries is their design as dry or wet batteries. This describes the composition of the electrolyte. In a dry battery,



Pressure pipelines of a pumped storage power station

the electrolyte is largely contained bound in a paper medium. All current primary batteries are made up of dry elements and can therefore be used in all conceivable operating positions. However, wet batteries are different, they are fitted with liquid electrolyte which can leak out easily if they are not operated or transported upright.

The following **battery systems** are currently on the market: zinc coal, alkali manganese, silver oxide, zinc air, nickel metal hydride, nickel cadmium rechargeable and, of course, the indestructible old lead type. In recent years, more and more lithium battery systems have been developed, either as lithium or lithium ion designs. These set themselves apart from all other battery systems with their longer storage life, constant holding of charge, robustness and high energy density.

Lithium and silicon on the up

Irrespective of these persuasive characteristics, development work is not standing still. More and more variants are approaching market-readiness. A team at the Massachusetts Institute of Technology (MIT) in Cambridge, USA, has now succeeded in developing **lithium air batteries** as an alternative



FEATURE

▶▶▶ to the classic version. Firstly, the research built a completely contained lithium air battery which no longer took air from outside. Instead, the oxygen remains in a condensed state. This prototype stores double the electric charge of a conventional lithium ion battery. To date, the first battery has been operated with pure oxygen and not with air. But the results thus far indicate a very promising start towards a usable battery. The researchers hope to achieve a practical prototype within just a year.



48 V micro hybrid battery by Johnson Controls: The lithium-ion storage is used in the vehicle in conjunction with a 12 V starter battery

Researchers at the Jülich research centre have been able to report similar success in pressing through the realisation of **silicone air batteries**. In theory, these have a much greater energy density and are also smaller and lighter than today's lithium ion batteries. They are also environmentally-friendly and insensitive to external influences. But the material is an even more decisive factor: after oxygen, silicon is the second most common element. It is cheap and available in almost unlimited quantities. The researchers are now looking for a way to keep the batteries running without having to top up the electrolyte. This is mainly a question of suppressing the battery self-discharge.

The team at the Institute for Soft Matter and Functional Materials at the Helmholtz-Zentrum Berlin (HZB) has

opted for a simpler approach. They have discovered that **lithium ion batteries** can increase their capacity six times over if the **anode** is made of silicon instead of **graphite**. For the first time, the Berlin-based team have observed how lithium ions migrate to silicon. Their work shows that even very thin layers of silicon are sufficient to achieve the theoretical potential capacity of the battery. Their work is published in the ASCNano journal of the American Chemical Society.

There is real flux in the current international battery market. Experts at Roland Berger estimate the market volume for 2015 at around 9 billion dollars for lithium batteries alone. It could be more than 50 billion dollars by 2020. But the experts are also warning about excess capacity. Even in 2015, production capacities outstripped demand two to one. Amid all the euphoria about lithium batteries, we should not forget the ancient indestructible lead battery. In terms of electromechanical battery systems, it still has a market share of over 90 %.

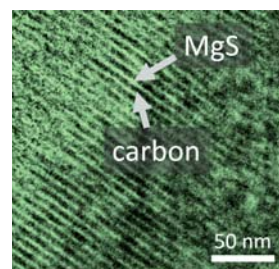

New electrolyte enables the construction of magnesium sulphur batteries

Electrolyte as an energy store

Redox flow batteries could also prove to be a possible future technology with their highly efficient energy storage systems. This battery type stores electric energy in the form of electrolytes. Here, too, it largely comes down to migrating ions. To date, the crunch point has been a membrane which separates two energy-storing electrolytes from one another. It should both hold vanadium ions and be permeable for the protons.

Researchers at the Leibniz Institute for Interactive Materials (DIW), the Aachen Process Technology Faculty at RWTH Aachen University and Hanyang University Seoul have realised a significant improvement to this key component. Thanks to this innovative membrane, the prototype achieved 100 successful charge and discharge processes in a week, with energy efficiency of up to 99 %, depending on Amperage.

Powercaps combine benefits

The Karlsruhe Institute of Technology (KIT) is taking a very different, very creative approach which aims to combine the positive characteristics of **batteries and condensers** in the form of a hybrid store called a **powercap**. Batteries have the advantage of absorbing lots of energy and storing it for a long time. The disadvantage is that the charging times are long and the service life limited. It is exactly the reverse for condensers. They are long-lasting with very rapid energy absorption, but have reduced capacities and a limited storage time.

However, Powercaps can store twice as much energy as conventional condensers and at the same time, theoretically provide up to ten times as much electrical energy as a battery. The scientists see the main applications for this technology where uneven power demands need to be met.

KIT and its partners are pressing ahead with the development of these Powercaps as part of a “FastStorage BWII” project sponsored to the tune of 25 million euros by the state of Baden-Württemberg.

A future for magnesium

Also at KIT, scientists have developed an electrolyte which is relatively easy to produce and can be used in **magnesium batteries**. Magnesium has the potential to deliver almost double the energy density as the more expensive lithium. In order to be able to use a

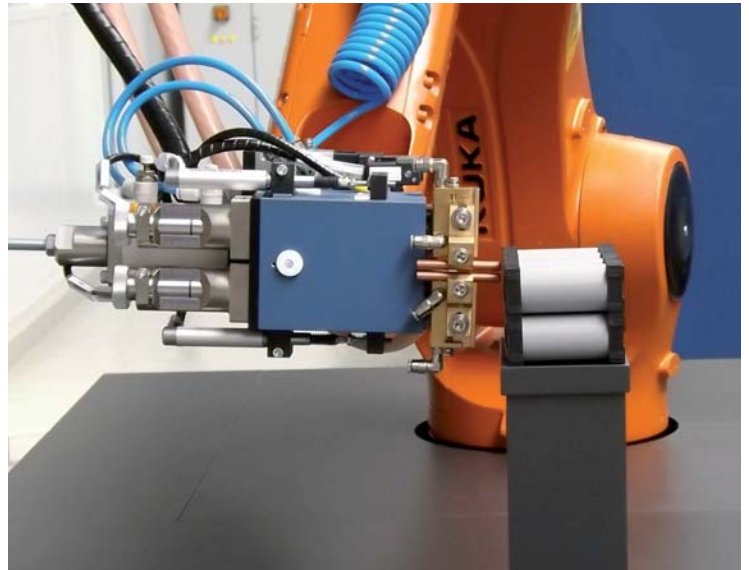

Module production of power caps: Individual cells are welded together by robots to form modules and are then interconnected to an energy storage

magnesium battery system on a reliable basis, it needs a very specific electrolyte as an ion-conducting system between the two electrodes. This newly developed electrolyte is electro-chemically stable and has a high level of effectiveness. The raw materials required are readily available and have good environmental properties. KIT is now looking for industrial partners to further develop and apply this new technology.



Tried and tested pump storage power plants

A great deal of energy can be stored on a temporary basis using **pump store power plants**. This technology has been in use for many decades. There are many pump storage power power plants in the Alpine area, including Austria and Switzerland. However, in Germany, there are limited opportunities for new plants because of the natural conditions. At the same time, there has for years been significant local resistance to new construction projects, as seen in the south of the Black Forest.

The principle of pump storage power plant is wonderfully simple: in times when electricity is cheaper, water is pumped from a lower tank to a higher reservoir.



FEATURE

Upper basin

Storage power station Kaprun near Salzburg

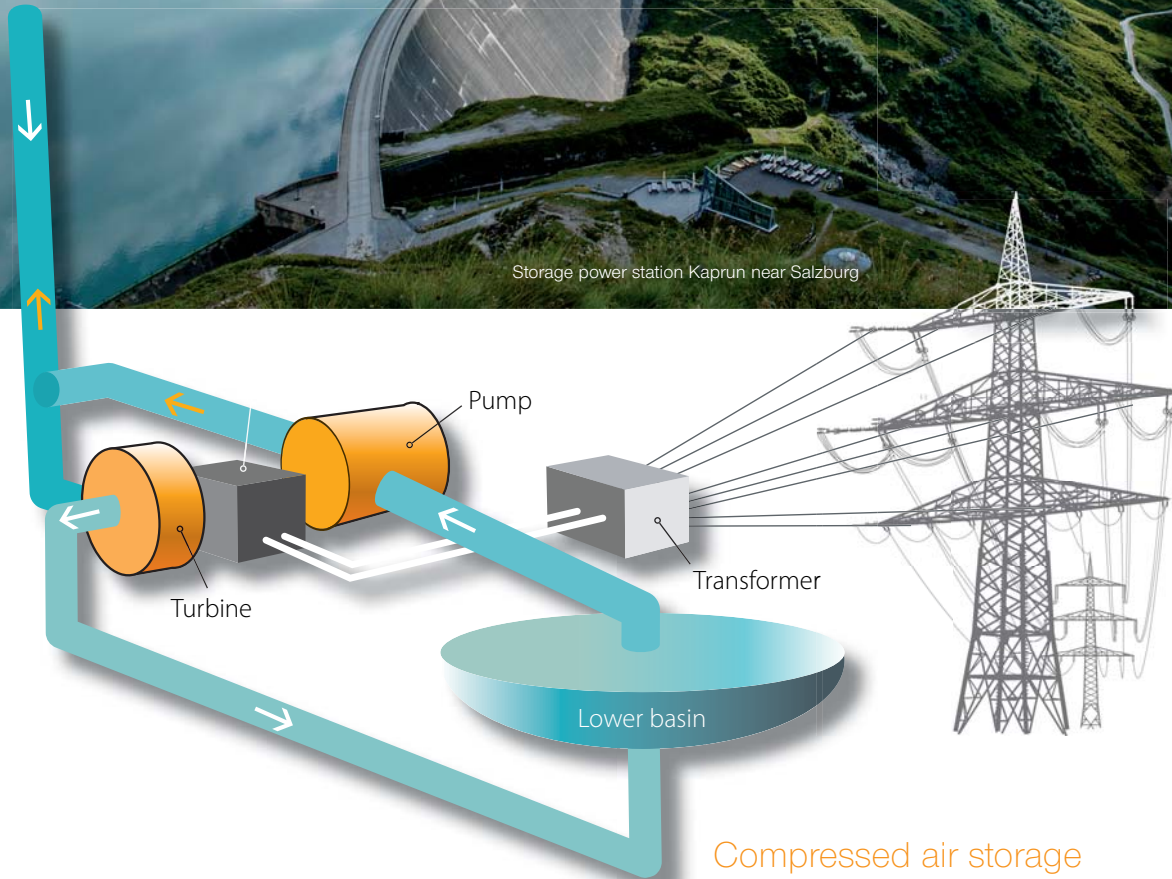

Compressed air storage power plants in pilot phase

▶▶▶ If general electricity consumption increases significantly, e.g. at lunch time, the stored water pours sometimes hundreds of metres down through massive steel pipes, driving high-performance turbines at the bottom to create electrical energy.

As the amount of water stored is normally very limited, this method can only be used for bridging energy supply bottlenecks on a short term basis. While the higher-level reservoirs were normally filled overnight in decades gone by, the storage process can now take place during the day at times when there is excess wind or solar energy. This is exactly why Germany needs more pump storage plants than are currently available.

Compressed air storage power plants can be built in different locations, but have significantly greater energy losses than pump storage systems. Added to this, it is very difficult to find suitable locations as they rely on large underground hollow chambers. The charging process involves compressors and compressed air. During the discharge process, the compressed air drives turbines. An innovative system of storing electricity in the form of compressed air is currently being tested in the Swiss Alps. This pilot system is unique anywhere in the world. Two powerful generators use excess electrical energy to press air into a tunnel. When power is required at peak times, the generator works in the opposite direction to generate electricity.

The tunnel is an unused tunnel to the north of Biaska in Tessin which was once used as a service tunnel to transport excavated material from the newly opened Gotthard Base Tunnel. The tests are being carried out in the central section of this tunnel, which is about 3200 m in length. This pilot project will cost Switzerland 4 million franks.

Hydrogen still too expensive

The generation of **hydrogen** is another option when it comes to storing electrical energy. The hydrogen extracted can be used to operate fuel cells to generate further electrical energy. Unlike with pump storage or compressed air storage power plant, hydrogen power plants can be built almost anywhere. However, they are significantly more expensive and also incur increased energy losses. At the same time, the hydrogen generated can also be used elsewhere, e.g. by feeding it into existing gas networks.



Energiepark Mainz: World's largest electrolysis system converts wind energy into hydrogen

Hydrogen is considered the energy source of the future. To date, the problem has lain in extracting the hydrogen. Currently, this normally involves electrolysis, steam reformation or biomass. The processes are complicated, meaning the hydrogen is still relatively expensive.

A new process is set to make the generation of hydrogen significantly more affordable. The catalyst used is key. Australian company Hazer has developed a method of extracting hydrogen extensively and cost-effectively, with no polluting emissions. The starting point is methane which is broken down. Heated iron ore is then used as the catalyst. When the gas comes into contact with the catalyst, it breaks down into its components of hydrogen and carbon. A pilot system should be in place by the end of 2017 which can produce 30 tons of hydrogen a year.

Short-term storage for vehicle construction

Flywheel energy storage systems are another method of storing energy. An electric motor sets a special flywheel into rapid rotation. On discharge, the electric motor acts as a generator. These energy stores are short-term stores with high output which have only been used sporadically in vehicle construction thus far, e.g. in electric buses used for public transport and, since 2009, officially in Formula One as KERS, a system for extraction of kinetic energy.



The storage capacity for compressed air is limited by a concrete insert with a diameter of 5 m and by a metal door

FEATURE



Biogas laboratory of the University of Hohenheim

"If necessary, it can be fed into the natural gas network at any time ..."

►►► Biomethane for temporary storage

And then, there is also the idea of converting excess solar and wind energy into **biomethane** via an interim hydrogen phase and thus storing it. If necessary, it can be fed into the natural gas network at any time, as proposed by the State Institute of Agricultural Engineering and Bioenergy at the University of Hohenheim in Stuttgart.

Based on the ever increasing proportion of renewable energies in the power supply and the resulting fluctuation in energy services, and given the network stability required, additional regulation measures are unavoidable.

CONCLUSION

As this summary makes clear, there is still massive potential for different storage options for electrical energy. International research is still gathering pace in a number of different directions. Leading German research institutions and universities are playing a not insignificant role. ■

*Karl-Heinz Wierz
Wirtschafts-Kommunikation Stuttgart*



Steve Mason,

former Managing Director of Bender UK, is transferring to the executive floor at Bender Inc. in the USA. His successor in the UK will be his longtime employee

Gareth Brunton.

Management changes

at Bender USA and Bender UK

Managing Director of Bender UK Steve Mason has been chosen to head up Bender Americas, the Bender Group's US business division, and takes up his new post on May 1st 2016. Based at the company's US headquarters in Philadelphia, Steve Mason will have responsibility for North America, Canada, Mexico and the Caribbean.

Dr Pieler is confident "Over more than six years as MD of Bender UK, Steve has consistently proven his leadership competence. There is no doubt in my mind that Steve's personality, knowledge and experience will be extremely valuable for Bender Inc." he commented.

"Bender in America encompasses a huge market ..."

Since 2010 the business has grown 20% year on year, extending its stake in existing markets while breaking into new business areas with bespoke applications of Bender's high technology solutions. Steve has also overseen development of Bender UK's 2,500 m2 new business premises in South Cumbria, with its forthcoming opening.

Mason is looking forward to the new challenges of the Americas operation. "Bender in America encompasses a huge market. I will be seeking to introduce some of the strategies which have proved so successful in the UK, taking into account the many significant differences in the US" he explained.

Bender UK Operations Manager Gareth Brunton will be new Managing Director. He joined Bender UK in 2003 and has risen through the ranks at Bender UK. He has made a significant contribution to the growth of the business, especially in the medical sector. Mason adds: "Having worked for so long with Gareth building the UK team I am confident that Bender UK will be in safe hands to enter a new era of expansion and continued profitability under this direction." ■

*Marita Schwarz-Bierbach
S-COM*

Working against the signs of the times

These days the supply of electrical power in medical locations is considered extremely safe and reliable.

The safety of patients and medical personal enjoys the highest priority. Essentially, this situation is due to the design of the installations in accordance with the standards and the priority given to hospitals by the utilities.

New installations are of course planned and installed according to the latest applicable standard.

The hospital standard

Since the first standard for medical locations, DIN VDE 107 in 1968, time and again there have been adaptations to the changing requirements. These adaptations became necessary due to the usage of more and more modern equipment in all areas of medical diagnostics and supply. In the meantime DIN VDE 0100-710 applies in Germany, HD 60364-7-710 or IEC 60364-7-710 across Europe and worldwide respectively.

To achieve a high level of security of supply in critical medical locations (e.g. operating theatres, intensive care units), the latest standard requires above all two special measures:

- a) The redundant design of the supply cables and
- b) the usage of an insulated power supply, the medical IT system.

Switching between the two cables must be automatic. The devices used must be "single-fault tolerant".

The continuous monitoring in the medical IT system must be designed such that all faults that can occur in modern equipment are detected.

As a consequence, monitoring devices are to be designed so they function reliably and are to be equipped with self-monitoring functions. Every time there is a fault, the medical personnel and the persons responsible for the building systems are to be informed. To verify correct function, the standard stipulates regular tests.

Before-After-Situation

Before

After



In this way two causes of malfunctions that cannot be excluded in practice are addressed: Malfunction in the supply infrastructure and malfunctions in the equipment used.

Since 1966 Bender has ensured the safe operation of hospitals and clinics with devices for monitoring medical power supplies as well as alarm indicator panels and test instruments. At the end of the 80s, automatic transfer switching devices were added and later the convenient insulation fault location systems (EDS) that considerably accelerated the search for faulty devices. Networked Bender alarm indicator and operator panels are the standard today in modern clinics.

Risk in old installations

The continuous work of the standardisation forums takes into account the technical further development of the equipment used in medical locations. The work of the forums ensures that new installations satisfy the latest requirements. But what is the situation for existing installations?

The fact that existing installations do not meet the latest standard could be categorised as a formality. However, if you consider the details, fundamental flaws become apparent:

- Many devices were not single-fault tolerant.
- Earlier measurement methods were suitable only for pure AC systems.
- In general messages were generated actively via contacts – due to the open-circuit principle, the signalling device has to be functioning correctly to generate the messages. It was not possible to generate a failure message. The failure of safety devices therefore often remained unnoticed.

If there are changes or additions to the installation, new tests are always required. But what is the situation with changes or additions to usage?

- Often more ME (Medical Electrical) devices that are completely different to those originally foreseen are used.

- Today areas are often used for purposes different to those originally planned. This situation results in a different classification with different requirements on the electrical supply.
- Due to the electronics contained in modern equipment, the connection of such devices loads the supply differently to that foreseeable at the time of installation.

All these issues should result in repeated consideration as to whether the installation still satisfies the current requirements. In addition, there is a further aspect: decreasing reliability due to the ageing of technical products, initially in relation to the mechanics:

- Malfunctions can be expected on old mechanical components (e.g. microswitches).
- Brittleness of mechanical components can result in fracture on activation.
- Resinification of lubricants makes mechanisms stiff, possibly even unable to function.

For the electronics the situation is similar:

- The ageing of electronic components (e.g. capacitors) can result in malfunctions or failures.
- The familiar "bathtub curve" shows the statistical distribution of component failures over time.

What is to be done?

For the reasons stated the conscientious installation operator is confronted with the same question time and again: "Is my installation (still) safe?". At the latest if there are doubts here it is time for an analysis of the latest requirements and the actual state of the equipment used.

First priority: functional reliability

Bender has set itself the objective of always being able to offer an operationally safe and contemporary replacement for just about every system already in the field so that hospital managers are again on the safe side before the ageing of the electrical installations becomes a problem.

With its sound advice coupled with the presentation of the latest state-of-the-art solutions compliant with the standards, Bender offers to upgrade existing systems to new levels of quality without the need for extensive capital investment. ■

Dipl.-Ing. Friedhelm Dalitz, T-SCT-PM

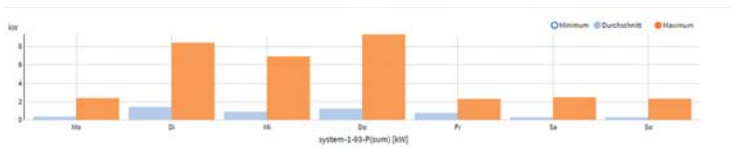

INNOVATIVE PRODUCTS



Monitoring and analysis of your electrical system made easy

POWERSCOUT®

POWERSCOUT® is the tool that allows you to operate your electrical system safely. The operating statuses of the system are automatically recorded with no manual intervention required. All available data is available to you anywhere and any time. This reduces the risk of production downtime and thus reduces production costs. POWERSCOUT® works for you and is quick and simple to set up and configure to your individual requirements.

What does POWERSCOUT® offer?

- Quick location of errors
- Energy monitoring
- Simplified documentation thanks to automated reports – e.g. meter readings –
- Quick generation of meaningful visualisations – e.g. using Wizards –
- No work involved in administering the software
- Records across multiple sites
- Real flexibility on visualisation and analysis – Dashboards, widgets and scalability –

How does it work?

POWERSCOUT® offers three major functions based on state-of-the-art web technology:

Visualisation and evaluation

- System status at a glance
- Flexible display design
- All content individually customisable
- The displays (dashboards and widgets) can be easily arranged by drag and drop.

Wizards

The built-in wizards help with the quick and simple generation of visualisations and automated reports. You can use the output from the wizards immediately or continue to customise it. The following wizards are currently available.

- Residual current
- Stray currents
- Central earthing point
- Neutral conductor
- Other wizards are in preparation.

Reports

The days of time-consuming reporting are over thanks to POWERSCOUT®. All dashboards created by you or the wizards can automatically be defined as reports and sent by e-mail, archived and downloaded in PDF format.

This saves, for example, many hours of work producing the reports required for the documentation of periodic verification.

What is required?

Your electrical system must be fitted with measuring devices and sensors. These provide the data for POWERSCOUT®.

You need what are known as collectors to transfer the data securely and reliably to POWERSCOUT®. Collectors are already installed in the Bender communications servers (Gateways) COM465IP, COM465DP and CP700.

Graphic 1

Technical contexts

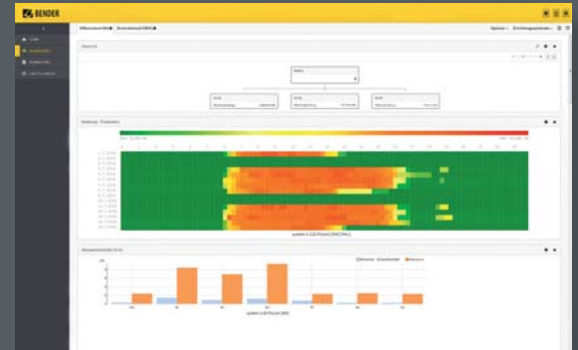
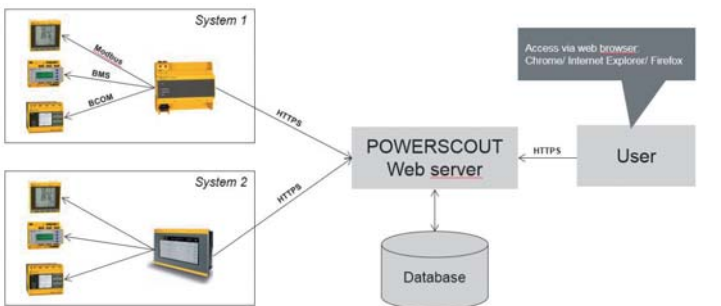

Graphic 2: Three example display elements

Internet access (port 443) is required for communication. Alternatively, you can work with a POWERSCOUT® installation in your local IT infrastructure.

Access to POWERSCOUT® is via your personal account, i.e. with a username and password. The consistent integration of the Bender system leads to a **commissioning time of less than 10 minutes**, thus ensuring implementation is a painless process. Graphic 1 shows the technical interactions.

All the display elements are already integrated into POWERSCOUT® and can be used by dragging and dropping. Of course, they can also be individually adapted.

For example, Graphic 2 shows the three display elements of topology, heatmap and measured value statistics. ■

*Dipl.-Ing. Joachim Wagner, T-SCT
B. Eng. Alexander Hegehofer, T-CF-PMO*

INFO

THE POWERSCOUT® homepage can be found at:
powerscout.bender.de

You can contact us directly to get your own personal access details.

INNOVATIVE PRODUCTS

For more than 30 years Bender not only has been a market leader but also the inventor of solutions for the localisation of insulation faults in complex, isolated power supplies, which are commonly referred to as IT systems. The following devices have helped many system operators to locate insulation faults quickly and reliably ...



Insulation fault location even more efficient and reliable

with the new insulation fault location system EDS440

The portable PKA3000 system was launched first, followed by the EDS family of devices - EDS2000, EDS1000 in the 19" rack, EDS470 and currently the EDS460. Bender insulation fault location systems are used in a wide range of applications, such as the systems in hospitals, power stations, industrial plants, offshore oil platforms or ships. It is already apparent that the latest insulation fault location system, the EDS440, looks set to continue the trend of successful devices from this series. With this device, insulation fault location becomes even more efficient and safer for the user.

The IT system

As described in DIN VDE 0100-410 and IEC 60364-4-41, section 411, the main advantage of an IT system is that a first fault does not lead to the automatic disconnection of the power supply and therefore prevents a complete system shutdown. Complex processes and production procedures are therefore not unexpectedly interrupted. On the contrary, IT systems can still be operated and controlled, and the fault can be rectified later when it is more

convenient to do so without having to incur high downtime costs. This is achieved by insulation monitoring systems (ISOMETER®) that comply with the product standard IEC 61557-8 (DIN EN 61557-8). Insulation monitoring systems monitor the insulation resistance of the IT system to earth during normal operation of the installation and reports if the resistance drops below a certain value. With complex systems that are distributed over a large area with dif-

How does an insulation fault location system work?

The system consists of a locating current injector and an insulation fault locator in connection with one or more measuring current transformers. Some devices, e.g. IRDH575 and iso685-D-P already include the locating current injector.

The sequence of operation is as follows: after the occurrence of an insulation fault, the respective alarm message is sent and the locating current for insulation fault location is automatically generated by the ISOMETER® without delay. Via the locating current injector and the insulation fault the circuit is closed and a locating current, dependent on the mains voltage, flows. The locating current is limited to a maximum value and flows from the locating current injector via the live lines, the insulation fault R_f and over the earth line (PE line) back to the locating current injector. It is detected by all measuring current transformers in this circuit and evaluated by insulation fault locators, such as the EDS440. Based on the assignment of the measurement current transformer to the circuit, the location of the fault can be determined.



ferent power supplies, the insulation fault localisation can be a complex and time-consuming experience for personnel.

The solution to this problem is insulation fault location systems designed in accordance with the product standard IEC 61557-9 (DIN EN 61557-9). These systems search for insulation faults during operation and automatically show any faulty circuits. This has the following advantages for the system operator:

- Disconnection of the system (or assembly) is not required.
- Working on live parts for fault location is not required. Risks to electrically skilled persons are avoided.
- Insulation fault location is done automatically during operation.
- Fault location is precise and is displayed.
- Details about the faulty circuit are available within seconds.
- The basic safety standard IEC 60364-4-41 (DIN VDE 0100-410) includes the following recommendation:

"It is recommended that a first fault be eliminated with the shortest practicable delay".

Fig. 1

Connection example EDS440-S and EDS440-L

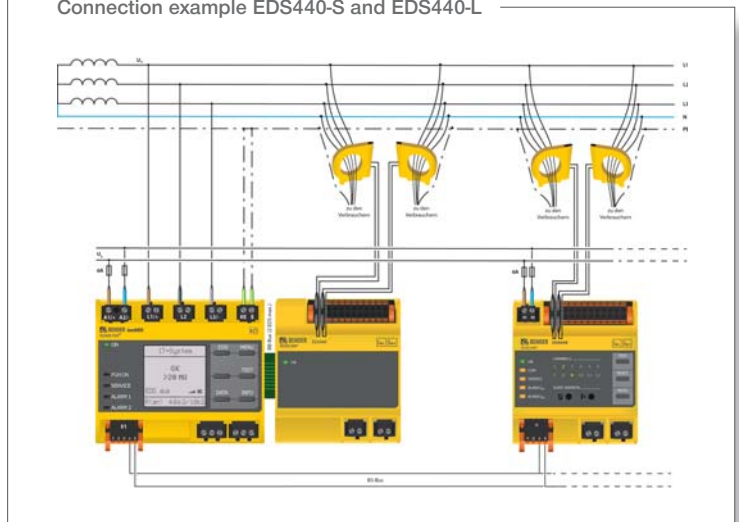

INNOVATIVE PRODUCTS

▶▶▶ Together we are strong

The EDS440 insulation fault locator is particularly adapted to the functionality of the iso685 insulation monitoring device. The variant iso685-D-P contains the necessary locating current injector for the insulation fault location. The iso685-D-P operating menu has been extended and adapted so that EDS440 settings can be easily made. An automated bus scan to detect connected EDS440 devices and the possibility to create individual alarm messages enables a very flexible application.

Space-saving and simple installation

There always seems to be a space problem in the control cabinets in which EDS insulation fault locators are usually installed. The benefit of the EDS440 is that the casing width is smaller. The current EDS460 series needs six subunits in width; the EDS440 requires only four. The depth is also more compact.

Connection is realised by plug-in terminals that are optionally available as screw or push-wire terminals. This in turn allows easy and fast installation as well as enabling an easy exchange of devices.

More efficient fault location

Measurement is based on the technology implemented in the EDS460 and EDS195P, but has been optimised according to the following criteria:

- Higher accuracy
- Reduced interference effects from the system to be monitored
- Residual current measurement with adjustable response values (RCM function)
- Improved connection detection for the connected measuring current transformers
- Higher sensitivity in combination with the series W ... AB measuring current transformers.

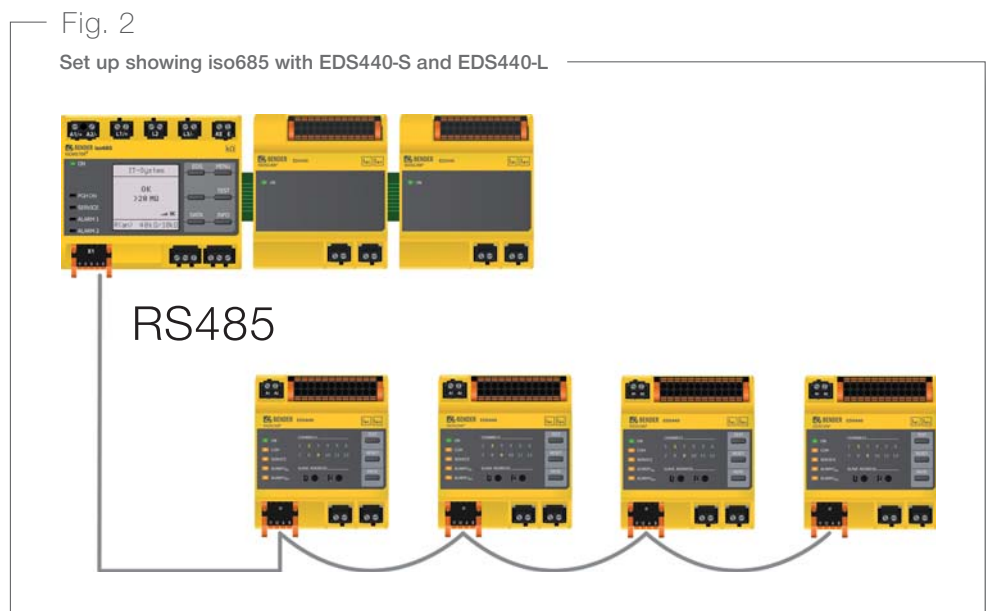

Basically, the series consists of four variants:

- EDS440-S and EDS440-L for use in main circuits with a response value of 2...10 mA for the generated locating current.
- EDS441-S and EDS441-L for use in control circuits with a response value of 0.2...1 mA for the generated locating current.

In systems where only one main distribution board is monitored by the EDS system, the ISOMETER® and insulation fault locator are often housed in a compact switching cabinet. For this purpose, the EDS440 series offers a further benefit through the use of a CAN based BB-bus (Bender Backbone bus). This is available on the rear of the iso685 and EDS440 and is routed via a special adapter in the DIN rail. This allows the iso685 and EDS440 to be directly installed side-by-side on the DIN rail. Communication and power supply run through the BB-bus without additional wiring of terminal blocks. The variants EDS440-S and EDS441-S – “S” stands for “sensor” - are available for this application. These devices do not have any operating or display elements. All settings and alarms are realised via the iso685-D-P.

In systems where sub-distributions are also monitored by EDS systems, it is normally required that the EDS440 has to be located at quite a distance from the iso685-D-P. In such cases, application of the BB-bus is no longer possible. By using the EDS440-L

and EDS441-L the devices can also be used over distances of up to 1,200 m with the iso685-D-P and they communicate via an RS-485 sensor bus. The EDS440-L and EDS441-L have corresponding operating and LED displays for the operation and indication of alarm messages on-site without the need to use the iso685-D-P.



Front view EDS440-L

Front view EDS440-S

With the new EDS440 series the user is offered a system with outstanding value for money. Equipped with the latest efficient technology for insulation fault location it is easy-to-use and to install. The availability of the installed power supply is significantly improved, and the resulting optimised maintenance leads not only to increased safety but the economic performance of technical systems in a wide range of applications is also significantly improved. ■

Helmut Becker, T-MIS-PM



The energy revolution needs storage

Germany is taking a pioneering role in the expansion and utilisation of renewable energies. Here the emphasis is on wind energy and photovoltaics. The power generated in this manner however fluctuates depending on the weather. This situation place new challenges on our energy supply, as the power available and the power consumed must always be exactly the same. Along with better power distribution, as is being discussed intensively in relation to the route for the Südlink high-power transmission line, electrical energy storage devices could contribute to solving the problem by compensating for brief fluctuations.

The safety of the required electrical storage systems must comply with certain rules, guidelines and standards. One of these is the **application guide VDE-AR-E 2510-2** in which the safety requirements on stationary electrical energy storage systems are formulated.

Fig. 1

Principle of an installation acc. VDE Rules of Application VDE-AR-E 2510-2

Application example for an electrical energy storage device < 30 kW, based on VDE-AR-E 2510-2 using an ISOMETER® isoES425, shown here as "IMD" (Insulation Monitoring Device)

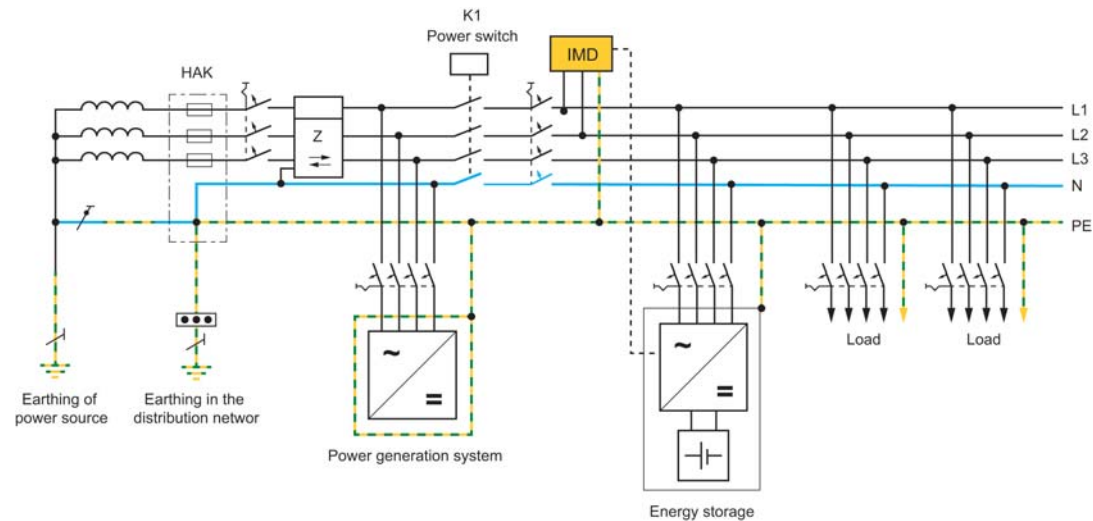

The application guide mentioned covers the planning, installation, operation, dismantling and disposal of storage systems with a fixed connection that are intended to be used for the connection to the low-voltage distribution system. Along with general requirements, this information also covers safe usage and operation as well as the requirements on the electrical installation and emergency standby operation. Here Bender offers a solution compliant with the standards in the form of the compact insulation monitoring device ISOMETER® isoES425 ("ES" stands for energy storage device).

Safe monitoring of energy storage devices in the low-voltage distribution system

The isoES425 monitors the insulation resistances of unearthed AC, AC/DC and DC systems (IT systems) according to DIN EN 61557-8 (VDE0413-8) and IEC 61557-8 and takes into account the application guide VDE-AR 2510. It is used to monitor and indicate the connection to earth during network operation. On operation as an isolated system, the isoES425 takes

over the monitoring of the isolated system (IT system). Two separately adjustable response values/alarm relays make possible early warning, long before the installation has reaches a critical state. Both the actual measured values and the alarm messages can be displayed on the LC display where the device parameters can also be set. The existing DC-supplied components present in energy storage devices do not influence the operating characteristics.

Straightforward installation for new and existing installations

The device can be operated with the voltages normally available in the switch cabinets by means of a wide-range power supply unit and AC 230 V or DC 24 V. The separately adjustable response values are in the range from 1...990 kΩ. Automatic adjustment to the system leakage capacitance is undertaken up to a value of 100 μF. The device is set in the factory to the alarm and warning values required in the application guide of 23 kΩ and 69 kΩ respectively. As such the device can be installed without any further settings.



▶▶▶ Monitoring large battery storage devices – innovative and precise

The monitoring of large energy storage devices by the insulation monitoring device ISOMETER® iso685-D for unearthed systems AC, 3(N) AC 0...690 V, DC 0...1000 V offers optimal safety. Faults between battery elements and/or sections are found and measured using the iso685-D. At the same time the offset voltage is monitored, which makes it possible to draw conclusions as to the location of the fault. The high-resolution, graphic display on the device is used to indicate the measured values as well as to make device settings. This display shows the changes in the insulation values over time using a graph, the isoGraph. A commissioning wizard rounds off the package and also simplifies initial commissioning.

Event-based fault analysis

The integrated data loggers save both measured values and device error and alarm messages in their entirety for the recommended device service life (up to 10 years) with exact allocation of date and time. Event-based fault analysis is therefore possible in conjunction with additionally acquired system measured data.

Locating faults using devices for insulation fault location

In large, physically extensive battery systems, it is often difficult and time-consuming to undertake insulation fault location. Continuous troubleshooting with additional location is possible easily and quickly using an insulation fault locator. As such it is possible to identify immediately the faulty battery section and start the repair.

Using the insulation fault location system from Bender, comprising an insulation monitoring device ISOMETER® iso685-D-P and an EDS440 (see page 16 et seq), insulation faults are found automatically during operation and the circuit with the fault indicated.

The investment costs for an EDS system pay for themselves in a very short time due to significantly reduced maintenance costs and avoidance of interruptions during operation. ■

M. Sc. Michael Breuer, S-EMEA

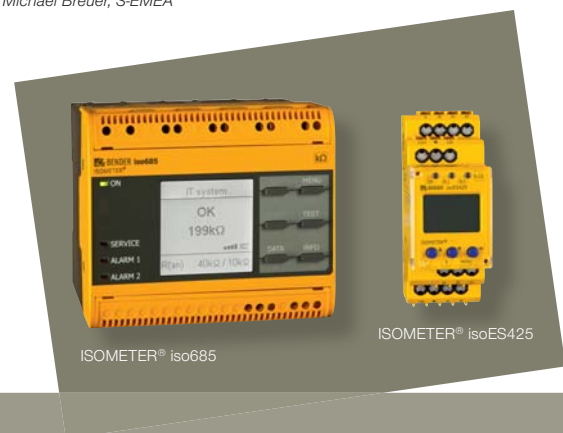

ADVANTAGES

of energy storage device monitoring using ISOMETER®:

- General protection of all persons present in the installation.
- Additional protection of electricians who do not need to search for faults on a live installation.
- Proactive maintenance to prevent unplanned shutdowns.
- No regular shutdowns necessary for the stipulated insulation tests, as measuring is continuous.
- Fault are located precisely
- The early detection of the smallest fault currents helps to prevent fires – insulation faults are the most common cause of fires.

INNOVATIVE PRODUCTS

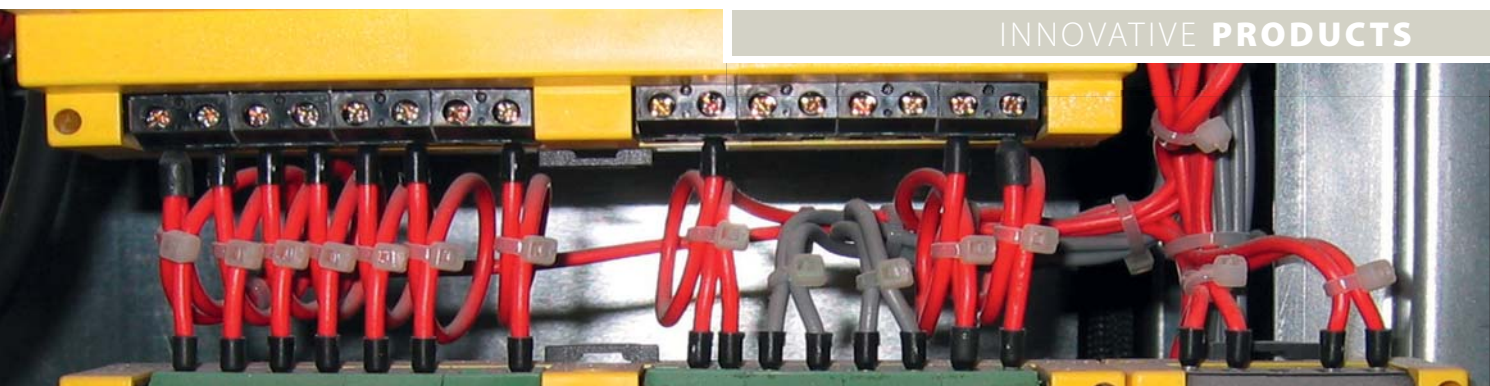

Control circuits and main circuits that are designed unearthed as an IT system are in principle monitored using insulation monitoring devices. A major advantage of this type of system is that the IT system offers very high availability.

Fast tripping and fast shutdown

... with the devices isoUG425, iso1685FR and isoNAV685-D

If there is a first insulation fault, there is no failure, the installations can continue to be operated. The insulation fault is signalled by the insulation monitoring device, finding and rectifying the fault can then be planned. The time for the measurement of the fault by the ISOMETER[®] is in general not very critical. A few seconds or minutes are quite acceptable.

Nevertheless, there are applications in which the response time plays a role. These include applications in which a load is only switched on for a very short time, if there is a low impedance earth fault, that is direct contact between an active conductor and earth, there is an unacceptable risk for persons, the production plant or even the product to be manufactured.

Control circuits with PLCs connected

A similarly critical assessment can arise if it is suspected that interference in the loads operated on the IT system is caused by the active measuring voltage that an ISOMETER[®] superimposes on the distribution



INNOVATIVE PRODUCTS



ISOMETER®
isoUG425



ISOMETER® isoNAV685-D

Fig.

Connection example isoNAV685 Ingeteam

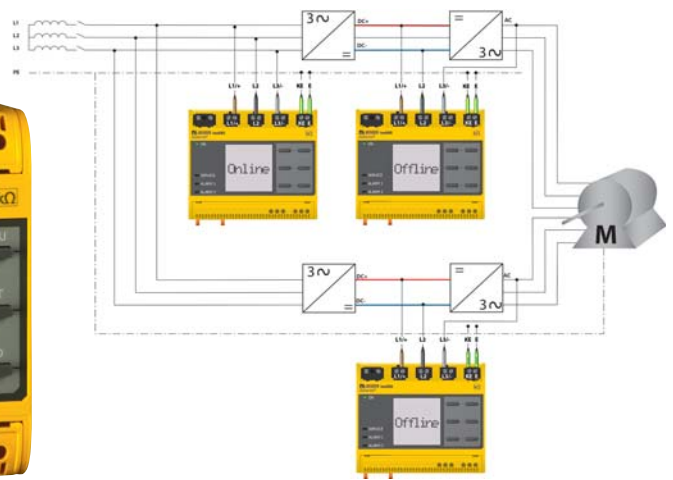

▶▶▶ network. These loads can include, for instance, sensitive PLCs as are very often used in production processes these days. In such applications the operating organisations often ask for insulation monitoring devices with special characteristics.

These controllers, with to some extent very sensitive control inputs, are mostly supplied from a DC 24 V supply. Insulation monitoring devices that operate using the active measurement method AMP (**A**daptive **M**easuring **P**ulse) can affect these sensitive control inputs in unfavourable cases. .

Therefore, in such applications a passive asymmetric measurement method like that in the insulation monitoring device ISOMETER® isoUG425 is advantageous. As a measuring voltage is not actively superimposed on the IT system, there is no PLC interference. A further, important advantage is the very fast response time of < 1 second. If a faulty input or output on the PLC is only switched briefly and therefore an insulation fault only occurs briefly, the isoUG425 can react quickly and signal the insulation fault.

However, it must be highlighted that the isoUG425 is not compliant with DIN EN 61557-8, as it does not detect symmetrical insulation faults. For this purpose the active measurement method required in the standard is necessary; this method is indispensable at higher voltages. In the conditions described and in particular at a voltage of 24 V DC, the passively operating isoUG425 provides very helpful information on the insulation state of the IT system.

Insulation monitoring with fast tripping in high-power supplies up to AC 3500 V

For the supply of electrical power to very costly production plants, along with insulation monitoring compliant with the standards and that operates absolutely safely, fast shutdown is also required to protect the plants.



ISOMETER® iso1685FR

Insulation monitoring with fast tripping in power supplies in which converter drives are retrofitted.

There are an increasing number of applications in which existing drives are replaced or supplemented with electrical drives. Here there is a clear trend to "more electric". The primary motivation for this trend varies depending on the application:

- Supplementing the main drive – mostly large diesel engines – in operating states in which these main drives are oversized and uneconomical.
- For short operating intervals when it is not worth starting the main drive.
- Electrical energy in the megawatt range is already available anyway in the application.
- Reduction of noise emissions.
- Reduction of exhaust emissions.

In these special applications, it cannot be excluded that a second insulation fault occurs very quickly after a first insulation fault resulting in damage to the plant. Together with the plant specialists at one of our customers, the following requirements were specified:

- Safe detection of symmetrical and asymmetrical insulation faults
- Response range 5 ... 500 k Ω
- Fast detection of earth faults in ≤ 150 milliseconds
- False tripping by the ISOMETER® is not allowed
- Redundant earth connection monitoring
- Coupling monitoring
- Offline measurement (insulation measurement in the switched off state)
- No device error message if no system voltage.

The insulation monitoring device ISOMETER® iso1685FR was especially developed for such purposes and is already successfully in use in many such applications.

If the converter drive offers advantages in the application, it seems reasonable to use the existing electrical supply, e.g. generators, also to supply an electrical converter drive. The electrical supply for this purpose should be designed as an IT system to achieve the highest possible availability for the drive. To further increase the safety of the drive, fast signaling is also required if the insulation level in the installation has dropped below a critical value **"AND"** an offset voltage exceeds a critical value.

An insulation monitoring device must therefore not only measure the insulation, but also the offset voltage and, above all, also output an alarm with a logical **"AND"** operator. To meet these requirements, the insulation monitoring device ISOMETER® isoNAV685-D was developed. It continuously monitors the entire insulation resistance of the IT system during operation and outputs a warning within 150 ms as soon as the response value of the insulation resistance is dropped below and at the same time the response value for the DC offset voltage is exceeded. The electric drive is then shut down quickly by the isoNAV685-D to protect the installation. ■

*Helmut Becker, T-MIS-PM
Dipl.-Ing. Dieter Hackl, T-MIS*

INNOVATIVE PRODUCTS

Insulation monitoring device

ISOMETER® iso1685DP

for unearthed AC, AC/DC and DC power supplies (IT systems) up to 1000 VAC / 1500 VDC



Insulation fault location up to maximum low-voltage limit

In accordance with the requirements of the currently applicable standards (e.g. DIN VDE 0100 series “Low-voltage electrical installations”), the maximum low-voltage values are 1000 V for AC voltage and 1500 V for DC voltage. In the planning and design of power supplies, these maximum voltage limits are reached to an increasing extent. This is due to the fact that higher electrical power values can be achieved with lower nominal currents. This offers a range of benefits to electrical installation contractors:

- Cable cross-sections can be reduced.
- Conductors and cables are lighter in weight and cheaper.
- As a result, manufacturing costs can be decreased.
- Power loss in the form of waste heat can be reduced.



Typical applications are photovoltaic systems, for example. In this sector, manufacturers of inverters increasingly approach the DC 1500 V limit.

Another example is the 400 Hz aircraft ground power supply. After an aircraft has landed and

reached its final parking position, the engines should be switched off as soon as possible. This can only be done after the ground power unit has been connected to the aircraft. Modern wide-body jets such as the A380 then have a power consumption of approximately 100 kW. Suitable frequency converters 3AC/50 Hz/400 V to 3AC/400 Hz/960 V are available at airports for this purpose. In order to minimize loss on the relatively long way from the converters to the aircraft, the maximum low-voltage limit is used here as well.

Both applications are generally designed as an insulated – i.e. IT – system. In accordance with the requirements of the applicable standards, the insulation of IT systems must be monitored during operation. For this purpose, the insulation monitoring device ISOMETER® iso1685DP with its central insulation measurement and insulation fault location functions provides an ideal solution. The monitoring device is equipped with a graphic display for alarm messages, measurement values and device parameters. These features and functions, along with the specified nominal voltage values, create a unique selling point. The iso1685DP can be connected directly to the voltage source without requiring any additional ballasts or coupling devices.



The integral insulation fault location function of the iso1685DP is a device feature recommended in the applicable standards. This feature rapidly pays off in large-scale installations. In the event that an insulation fault is signalled by the insulation monitoring device, the internal locating current injector is activated manually or automatically without changes to the installation. Using a built-in and/or portable insulation fault locator (e.g. EDS460-D and/or EDS195P), faulty parts in the installation – in large-scale PV installations even the faulty module – can be quickly identified. There is no need to shut down parts of the installation to do this.

The use of an insulation fault location system is extremely important in aircraft ground power supply. This necessity has been recognized at an early stage in the extension of Munich Airport. The new terminal building is almost 1 km long. During the first construction phase in the early 1990s, an EDS1000 was installed for insulation fault location, which has continued to work reliably ever since. The complex mounting configuration of this installation in a 19" rack includes an ISOMETER®, a coupling device and a locating current injector, plus one insulation fault locator per outgoing circuit (aircraft supply).

By contrast, the iso1685DP combined with the EDS490-L for simultaneous monitoring of 12 outgoing circuits provides a very compact and fast solution. Using a COM465IP gateway, the communication interfaces of the devices can be linked to an airport's intranet. This ensures comfortable and reliable monitoring and recording of the system state. At the same time, maintenance intervals can be extended, saving costs.

Fig. 1

Schematic diagram of PV installations up to DC 1000 V

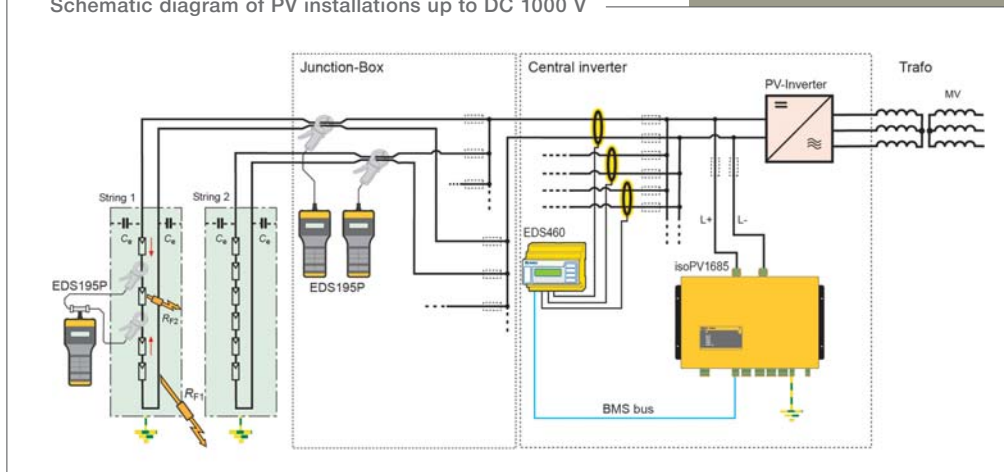

In the two applications described above, but also in other sectors, the iso1685DP offers plant operators a safe and compact insulation monitoring solution across the entire low-voltage range up to the maximum voltage limit. ■

Helmut Becker, T-MIS-PM

On this topic, TÜV Süd is offering a 2-day event together with Bender. See seminar announcement on page 48.



TECHNICAL APPLICATION

Pumped-storage hydro power station Bad Säckingen:
Fit for public energy supply

High availability guaranteed

For the energy supply in Germany

pumped-storage hydro power stations are so far the only economically significant opportunity for storing an electricity surplus. If required, this can be made available within a few minutes thus assuring an optimized capacity utilisation of the energy provided along with other power plants.



Special importance is attributed to pumped-storage hydro power stations in case of large-scale power outages. Thanks to their black start capability, they can be used for starting other power stations like coal-fired power stations which are not black start capable. Furthermore, the use of renewable energies is supported by using these power stations since they compensate for the unavoidable fluctuations of these power generators.

The power plant of Bad Säckingen is a pumped-storage hydro power station of the Schluchseewerk AG with a 360 MW generator and approx. 300 MW pump output. It is situated in a cavern of 160 m in length, 23 m in width and 33 m in height which can be reached through an access tunnel of 1.5 km in length. Some 400 m above, the Eggberg basin is situated from which the water falls vertically into the depth through a steel-lined pressure shaft.

The power station produces an annual average of 400 kilowatt-hours of electricity. At the time of its building, it was the first German pumped-storage hydro power station in cavern-type construction and the second one in Europe after the pumped-storage hydro power station of Vianden which was brought into operation a short time before (1964).

Our mission: High availability and safe power supply

Now, the underground hydro power station which was built from 1961 to 1967 should be made fit for the future. The first step was the partial renewal of the electrical installations and instrumentation and control systems. The nearly 50 years old 20 kV/400 V switchgear had to be completely renewed – without interrupting the power supply.

To ensure this during ongoing system operation, the Schluchseewerk AG in Bad Säckingen has opted for the positive experience of the pumped-storage hydro power station of Waldshut in residual current monitoring and decided in favour of a permanent monitoring of the power supply with the help of technical systems from Bender. In this way, not only high operational safety but also high availability of the system is ensured.



System monitoring in earthed systems (TN systems)

Residual current monitoring system

The continuous monitoring of the insulation resistance current monitoring system RCMS meets the requirements on continuous monitoring according to IEC 60364-6. Thus, there is no need any more to shut down the related section for the insulation test (R_{ISO} measurement) within the framework of periodic verification. A deterioration in the level of insulation is detected and reported during ongoing system operation. All other measurements and works for performing the periodic verification can also be done during ongoing operation.

CEP monitoring

For assuring an EMC compliant operation of electrical installations, a TN-S system with a single central earthing point (CEP) is required according to DIN VDE 0100-444. This should be permanently monitored, since the entire leakage current of the electrical installation exactly flows at this measuring point.



"To ensure the ongoing system operation,
the Schluchseewerk AG has opted for the positive
experience of the pumped-storage hydro power station
Waldshut in residual current monitoring ..."

TECHNICAL APPLICATION

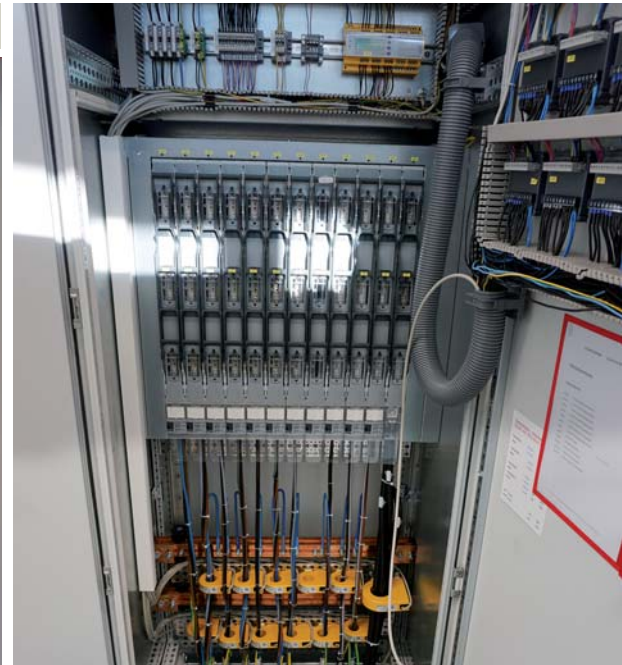

►►► Sudden changes in the measured leakage current point out a new PE-N bridge, a PE-N swapping or a low resistance earth fault. Thanks to the history memory of the Bender monitoring devices, the time stamps when significant changes have occurred are precisely traceable. In addition, the reason (e.g. maintenance or conversion work) and the location of the fault can be detected.

Minimizing the risk of fire

The residual current device (RCD) with a rated residual operating current I_N 300 mA provides comprehensive protection here. If residual current devices (RCD) cannot be used for technical reasons in some applications, the guidelines for damage prevention of the German Association of Non-life Insurers (VdS) recommend the usage of residual current monitors (RCM) according to DIN EN 62020 (VDE 0663) equipped with

switchgears e.g. like circuit breakers. But the prerequisite is that their supply voltage is independent from the supplying system (refer to VdS 2033).

Conversely, thanks to the lacking low-resistance connection of an active conductor, any high fault current with a risk of fire cannot flow on the first insulation fault in unearthed systems (IT systems).

Central system overview

Due to permanently rising energy costs, energy efficiency is gaining increasing importance. However, appropriate measures for saving energy can only be developed after having determined the energy flows within the system. Energy meters for DIN rail mounting are particularly suitable here. Apart from the energy meter, a power meter provides information on the total harmonic distortion and can also be used for troubleshooting in the event of a fault.

For monitoring the voltage quality, a PEM735 network analyser will be used here. The class A network analyser offers weekly reports for download via an integrated web interface. A central system device (CP700) collects the values captured by measuring devices through different bus systems (Modbus RTU, TCP, BMS) and centrally provides the corresponding data on energy consumption and power flows. In this way, a web server access can be used to check the condition of the installation via PC or smartphone. The installation of a special software is not required.

System monitoring in **unearthed** systems (IT systems)

Insulation monitoring device

In order to ensure a permanent and highly available power supply of the 20 kV switchgear, the supply voltage was designed as an isolated DC 110 V control voltage supply system. The DC 110 V system is made available through a rectifier and is battery buffered in order to avoid the control supply voltage of the installation to fail.

The advantage of the IT system is that there is no need to shut down the system on a first insulation fault. Thus, high operational reliability and a related high efficiency will result.

By using an insulation monitoring device, the system is permanently monitored and system maintenance can be planned independently of the insulation level. The insulation monitoring device constantly records the measured insulation resistance and represents its development as a graph. In this way, there is no need to perform the R_{ISO} measurement during the periodic verification, since the system is permanently monitored and each deterioration of the insulation resistance is immediately reported.

Equipment for insulation fault location

If an insulation fault occurs in the control voltage system of the 20 kV switchgear, this has to be detected and eliminated as quickly as possible. Troubleshooting starts automatically when an insulation fault occurs due to the used equipment for insulation fault location. The insulation monitoring device with integrated locating current injector feeds a limited locating current into the network which can be detected in the defective circuits by an insulation fault locator with connected current transformers.

After having detected the insulation fault, the corresponding customer-specific text is shown in the display of the insulation monitoring device thus avoiding failures and reducing costs.

Recognising connections

The new POWERSCOUT® system enabling comfortable monitoring and documentation is an additional option. Thanks to this option, several power stations can be monitored all together very simply and parameters can be formed for instance across different sites – and all this without the need to install any software or additional hardware. The installation work is marginal, since all devices automatically transfer their status values to a central memory where a central data analysis is performed. The user only works with a standard browser without the need to install local software. The creation of almost any reports is possible and supported through pre-configured standard reports.

In this way, Bender technology helped to realise such a complex project. The nearly 50 years old switchgear was thus completely renewed – without interrupting the power supply. This was a very important factor for all responsible employees of the maintenance division. "We were always connected to the system," Robert Schäuble, Asset Management Elektrotechnik, says. ■

*Dipl.-Wirt.-Ing. Thomas Fröbinger, Techn. Büro Mannheim
Dipl.-Wirt.-Ing. Michael Faust, S-EMEA
Dipl.-Ing. Jörg Irzinger, T-MIS-PM*

One of the world's most modern water jet plants

for the production of nonwovens for technical applications relies on electrical safety technology from Bender.



NON-STOP QUALITY

Quality, reliability and customer satisfaction – that is the credo of Tenowo, a subsidiary of Hoftex Group AG – nonwovens division – with production sites in Germany, the USA, in China and India. As a manufacturer of nonwovens, the production site in Reichenbach/Vogtland manufactures high-quality nonwovens for the automotive industry and construction industry around the clock.

The production of nonwovens is an energy-intensive process and the energy demand can only be covered electrically for process-related reasons, for example for ventilation systems and compressors for the water jet machines. It is particularly where electrical power and water come together that increased caution is required.

- **When can we find the time to shut down for periodic verification?**
- **What happens if a fault in the electrical installation unexpectedly interrupts production?**
- **Where does the energy flow?**
- **And what is the real state of my transformers?**
- **Is the network operator supplying the agreed quality?**
- **And above all: Are the people in the works protected at all times?**

The technical team at Tenowo asked themselves all these questions.

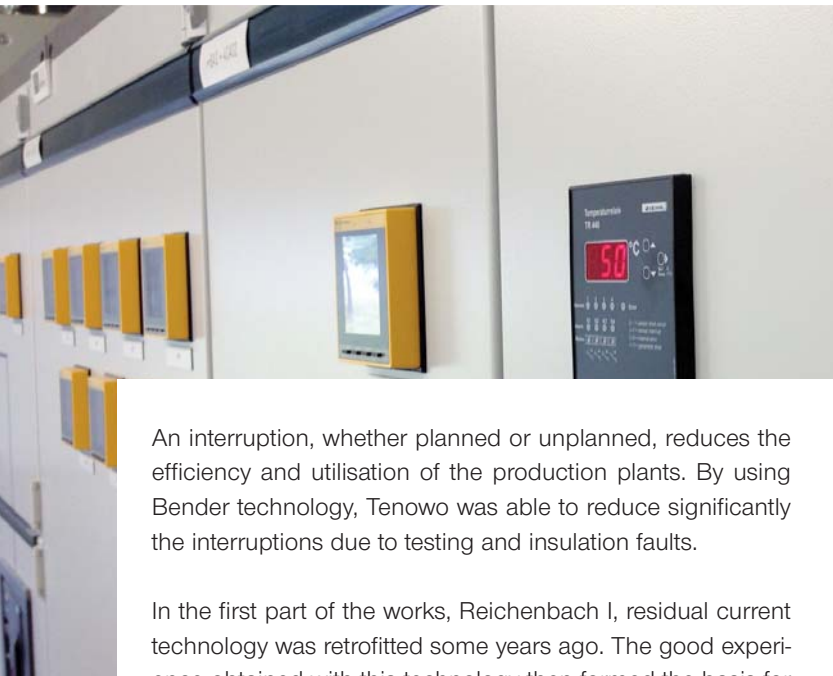

An interruption, whether planned or unplanned, reduces the efficiency and utilisation of the production plants. By using Bender technology, Tenowo was able to reduce significantly the interruptions due to testing and insulation faults.

In the first part of the works, Reichenbach I, residual current technology was retrofitted some years ago. The good experience obtained with this technology then formed the basis for its integration in the new installation during the construction phase. AC/DC sensitive residual current measuring technology has been in use there since day one.

Bender supports the customer with its residual current monitoring system in the product family LINETRAXX®. Machines and installations are continuously monitored for residual currents – an indication of insulation faults. If an insulation fault occurs, the customer is informed immediately.

Of course, all circuits in the five low-voltage distribution systems (LVDS), the central earthing points (CEP) for the LVDS and the safety power supplies are monitored for DC/AC residual currents to suit the application. As such this configuration meets the requirements on continuous monitoring according to IEC 60364-6 and replaces traditional insulation measurement. By recording the events using the Condition Monitor COMTRAXX® CP700, the condition of the installation is documented in a revision-proof manner.

As a company, certified according to ISO 50001:2011, Tenowo is required to record and depict energy flows. Also here Bender offers the optimal solution for the recording of the consumption-related data with the devices in the product series Power Quality and Energy Management (PEM).



LINETRAXX® PEM735

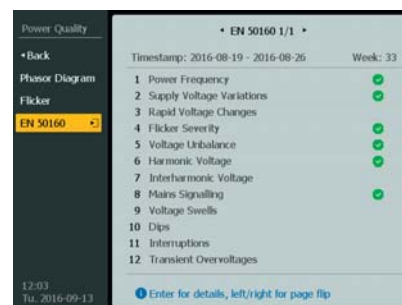

Screenshot EN 50160 report

A further function that is used on the Reichenbach site is the continuous analysis of the situation on the utility's grid. Each of the five 1,250 kVA transformers is monitored by a LINETRAXX® PEM 735 Class A Power Quality measuring instrument. As such the EN 50160 reports for each transformer for the last 52 weeks are available to the operating organisation for downloading. The EN 50160 report evaluates the local voltage quality, based on the characteristics defined in DIN EN 501610:2011-02*. These reports, which are generated automatically by the PEM 735 without any installation or reading effort, enable competent exchange of information with the utility in the event of damage.



* DIN EN 50160:2011-02
Voltage characteristics of electricity supplied by public distribution networks

"During the planning of the extension of our highly modern works in Reichenbach, a combination of residual current monitoring and energy meters with network analysis appeared to us to be a cost-effective, technically perfect solution. During the implementation, the staff from Bender also integrated products from other manufacturers in their system."



Customer comments

TECHNICAL APPLICATION



COMTRAXX® CP700

A dedicated PEM 735 is also installed on the emergency power generator to evaluate the compliance of the emergency supply with the standards.

The heart of the system is the CP700, which as a local touch-panel records data from 75 Bender devices:

- PEM735 – class A network analyser
- PEM333 – energy measurement on circuits
- RCMS460 – residual current monitoring with W...AB current transformers
- Transformer temperature modules from a different manufacturer.

and then processes and displays these data and sends them via Ethernet.

The software supplied offers numerous functions that make it possible to operate the installation in a straightforward and comprehensible

manner and that permit the detection of potential faults at an early initial stage.

Thanks to the usage of a wide range of Bender devices on one system, today Tenowo has a constant overview of the consumption and the condition of the insulation of its installations. The integration of devices from other manufacturers in the Bender communication system makes it possible for the customer to further process also non-electrical, physical data. This is a major benefit, as the customer saves the need to set up a parallel reporting infrastructure.



All values are transmitted via the CP700 to the headquarters in Hof an der Saale. Exact diagnostics on possible faults are ensured via the integrated web server. In this way service visits to Reichenbach, 60 kilometres away, can be optimised. ■

Rainer Schmidt
Hoftex EW-Zentrale
Zentrale Elektrowerkstatt

Bernd Häuslein, BGER

INFO

More information at www.tenowo.com



Streetscooter delivers letters and parcels electrically

CO₂-free delivery

The times in which you heard the postman coming from a long way off will soon be a thing of the past. Deutsche Post DHL Group will in future base its letter and parcel delivery service more and more on a CO₂-free and low noise approach and will rely on electrical safety technology from Bender for this task.





▶▶▶ **Streetscooter is the name of the yellow electric vehicles** that in the meantime are already on the move across the country. The new vehicle type was developed by the subsidiary of the logistics concern StreetScooter GmbH in co-operation with RWTH Aachen University specifically for the German postal service. The 1,000th, around 4.60 metre-long box-shaped vehicle came off the line in August 2016; it is powered with electricity from renewable energy sources such as sun and wind.

Economical and ecological

With the usage of these electrically-powered transporters, which above all are simple, robust, cheap and functional, the delivery of post is becoming more environmentally friendly, more sustainable and quieter, without renouncing efficiency. Although the vehicles, which travel at up to 85 kilometres per hour, do not have a massive range with their around 80 kilometres, thanks to the large load area they carry between 100 and 150 parcels on a route. Particularly on delivery routes where it is necessary to stop, pull away and brake many times, the high efficiency of the electric motor is especially apparent. The vehicle has a power rating of 30 kW, which is generated by a lithium ion battery and an asynchronous motor. Particularly in cities the clean, whisper-quiet drive is not only of benefit for the climate, environment and health, but also for the quality of life.

Extremely cost-effective in comparison to conventional delivery vehicles are the around 50 % lower maintenance and service costs and the up to 80 % lower repair costs, the low power consumption, the economic attractiveness of electrical power compared to petrol or diesel and the avoidance of a large number of mechanical wearing parts.

The production of the electric delivery vehicles is subsidised with around 9.5 million euros by the Federal Environment Ministry. By the end of the year around 2,000 Streetscooters are to be in use, 10,000 electric vehicles will be produced annually in Aachen from 2017. In the medium term the German postal service will gradually replace its complete delivery fleet in Germany with electric vehicles. In this way the company intends to improve its CO₂ efficiency compared to 2007 by 30 % by 2020.



Bender provides safety

In electric and hybrid vehicles there are voltages present that require the careful harmonisation of protective measures so they are safely controlled. Insulation faults in the power supply system/voltage class B system (on-board electrical system), as can occur e.g. due to temperature effects, soiling, moisture, faulty connections etc. must be prevented or detected and rectified. It is therefore important to monitor continuously the insulation resistance so that a warning about critical, low insulation resistances can be provided in good time.

The insulation monitoring device ISOMETER[®] iso165C for unearthed DC drive systems (IT systems) has been used to detect insulation faults at an early stage and to prevent hazards in the Streetscooters since the start of their success story.



Active continuous monitoring



Insulation monitoring device
ISOMETER® iso165C

Here an active measuring method is used. With this active method test pulses are coupled into the system with high impedance and the pulse response of the system measured. The insulation resistance can then be calculated from the pulse response.

Such an active insulation monitoring method also makes it possible to undertake diagnostics on deenergised systems, e.g. before switching on the high-voltage (HV) battery. With this method symmetrical and asymmetrical faults are detected with a high accuracy and all galvanically connected components are monitored – from the battery to the individual motors or HV loads. In addition, the insulation monitoring device can detect faults on the 12 V side from the HV side. The active measuring method therefore increases the electrical safety in the electric vehicles as faults are not only detected while the vehicle is in operation, but before the vehicle is started. The device can be seamlessly integrated into the existing CAN environment using the CAN interface on the iso165C.

Due to the small space it requires and the optimised measurement technology, the device is ideally suited to use in hybrid vehicles or fully electric vehicles and meets the increased requirements on the environmental conditions in the automotive sector (e.g. temperature and vibration, EMC). As such Bender is also helping to meet the climate protection goal. ■

*Michaela Heck M.A., textwerk-heck
Dipl.-Ing. Frank Mehling, T-MIS-PM*

The requirement from the standard ISO 6469-3:2011 that the minimum insulation resistance of the on-board electrical system must be ensured for the entire service life and under all operating conditions is met perfectly by the iso165c. It monitors the insulation resistance between the active high-voltage components of the electrical drive system ($U_n = DC\ 0\ V...600\ V$) and the reference earth (chassis ground) and continuously measures the insulation resistance between high-voltage cables and the vehicle chassis at a maximum on-board electrical system voltage of 600 V.

INFO

You will find more information at
www.streetscooter.eu

TECHNICAL APPLICATION

Bender technology in solar cars, not just for Down Under

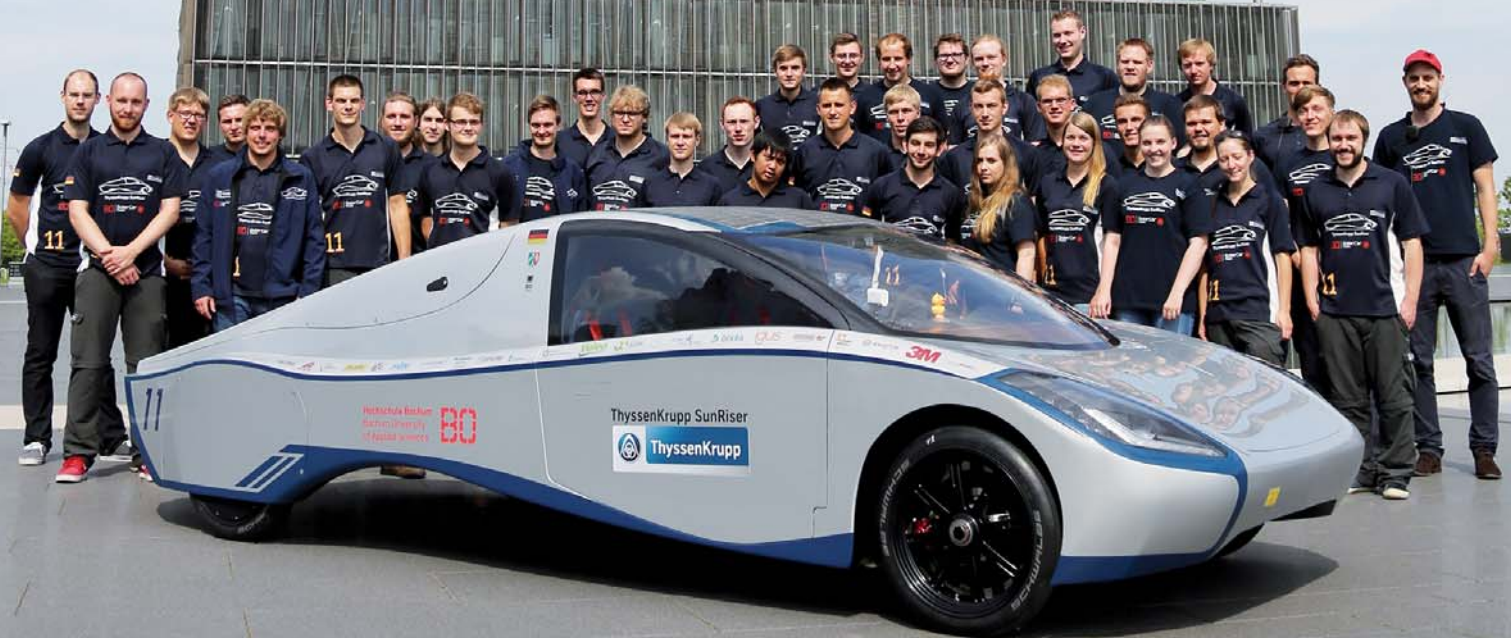

Sporty electro-mobility with solar energy

The University of Bochum has been researching electro-mobility for more than 15 years. Since then, students have developed and built six solar cars to take part in international competitions. The highlight of each two-year project cycle is the World Solar Challenge, the world championship for solar cars in Australia, where the competition entries from Bochum are always considered among the most innovative.

The project is not only very successful in competitions. The “SolarWorld GT” energy self-sufficient circumnavigation of the globe in 2012 resulted in an entry in the Guinness Book of Records, and the German Solar Prize 2015 also went to Bochum.

The vehicles are electric cars which have not only a high-voltage battery as used in conventional electric vehicles, but also use energy from the sun. The solar cell surface on the latest car “thyssenkrupp SunRiser” consists of 3 m² of gallium arsenide cells and supplies energy to charge the battery up when in motion. The lightweight bodywork is very important for an energy-efficient car, which is why it is primarily made from CFK fibre-reinforced plastic (carbon). This material also offers excellent collision protection, as safety is a key priority if solar vehicles are to be used on an everyday basis. The wheel

hub motors have also been built in-house for some years and are optimised with every project cycle. The help of a range of supportive partners is and remains crucial and of real importance.

Since 2013, Bender has been our partner on insulation monitoring with its insulation monitors. In the “thyssenkrupp SunRiser”, an ISOMETER® IR155 monitors insulation resistance and transfers this data to the strategy team. As well as insulation resistance, numerous other data is analysed in the vehicle. This includes battery cell voltage, temperature, current speed and the current charge output of the solar cells. The monitoring of the different parameters means potential errors can be identified at any time. As well as monitoring the vehicle, the strategy team deals with important strategic decision during the race. An optimum relationship between speed and energy-efficient driving must be guaranteed. At the end of the day, the combination of technical development and correct strategic implementation could be the difference between winning the race and losing it.



Reaching the finish line at the World Solar Challenge 2015 in Australia



Bender insulation monitor in the battery box of the “thyssenkrupp SunRiser”



TECHNICAL APPLICATION



The current "thyssenkrupp SunRiser" on the Hidden Valley Raceway in Darwin, Australia.

▶▶▶ The nearly 65 members of the team are now developing what will be the seventh solar car. This project cycle is also set to produce an everyday vehicle alongside other impressive innovations. For the first time in the history of the SolarCar project, a professional designer is also on board to bring the aerodynamics and design to a new level in line with his masters dissertation. The current development phase involves developing and testing bodywork designs but also new features to get one step closer to driverless cars.

The Solar Car project at the University of Bochum also took part in the European Solar Challenge in Belgium this year. With an impressive fleet of vehicles (three solar cars, two electrically powered freight bicycles and two solar buggies) the teams travelled from Bochum in September to compete against other teams from Europe and two Tesla Model 5s as part of a unique 24 hour race for solar cars.

There were four disciplines in the overall scoring: KO chicanes, presentations, fastest lap and distance travelled. The "thyssenkrupp SunRiser" had the fastest lap, the

"SolarWorld GT" won the KO chicanes. All the German teams performed well in the race, so the tension was high when the final winners were announced.



The SunRiser came out in 3rd place overall and everyone was relieved and proud that the hard work and exciting times had all paid off. ■

*Antonie Bauer, University of Bochum
Axel Mommers, University of Bochum
Svea Michardt, University Bochum*

INFO

Further info on the project at:

www.bosolarcar.de

www.facebook.com/SolarCarHSBochum



Contact: solarcar@hs-bochum.de

ABOUT WSCAD:

WSCAD is a software platform from WSCAD electronic GmbH (Bergkirchen, Germany). The modern, scalable E-CAD software supports the entire electrical planning and documentation process. Of relevance in conjunction with the usage of products from Bender are, in particular, the modules for working with circuit diagrams as well as switch cabinet planning.

www.wscad.de
www.wscaduniverse.com

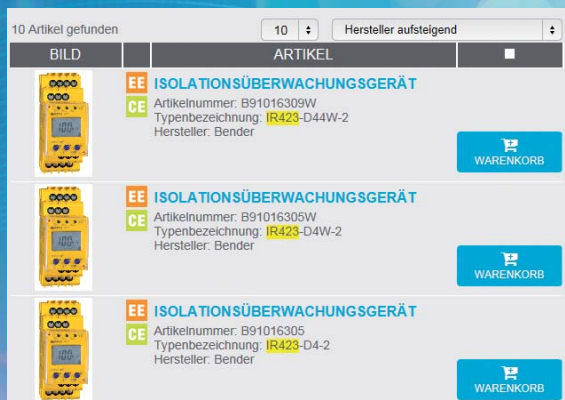

Fig. 1



Fig. 2

From the device library to the circuit diagram and onto the mounting plate

Bender in the data portal wscaduniverse.com

More than 600 items of Bender device data have been available in the WSCAD data portal.

These data ensure straightforward usage of the Bender product portfolio. The data portal uses standardised article data sets that, along with technical details and ordering information, also provide graphic and logic information for planning using WSCAD.

The WSCAD data portal makes it possible to select Bender products from an online catalogue and then to drag them to the circuit diagram as well as the switch cabinet layout diagram using drag & drop. Working with pre-defined device data accelerates planning, increases quality and eases the organisation of master data.

It is possible to search the WSCAD data portal based on various criteria. Figure 1 shows the result of a search for the "Manufacturer Bender" combined with the search term "IR423". The most important information for each article is displayed clearly. The symbols between the photograph and the article description show which WSCAD modules the article

supports. In the specific example the modules **EE** (Electrical Engineering) and **CE** (Cabinet Engineering) are supported. Clicking the symbols displays the logic information available (Figure 2). For instance terminals 21, 22, 24 are for a changeover contact.

On the selection of the devices from the WSCAD data portal, all basic information such as dimensions, electrical characteristics, order numbers, etc. is available immediately. These data flow into a wide range of planning steps, such as the electrical wiring, positioning on the mounting panel, the parts list or the documentation.

SUMMARY

Bender is supporting the straightforward engineering approach by providing device data for many products. It is no longer necessary to enter data manually with the related possibility of mistakes. Following on from the successful provision of data in the EPLAN data portal since 2014, Bender is now supporting another leading provider in the E-CAD software sector with WSCAD. ■

Dipl.-Ing. Frank Baier
S-MAR



Mohammad Anwar Mirza



Talha Anwar Mirza



Praveen



Helal



Syed Ali Arslan



Wakkas Anwar Mirza

AL SANABEL TECHNOLOGIES LLC

Proud representative of Bender GmbH & Co. KG in Dubai, Qatar and Pakistan

Five years of integrated safety solutions for medical equipment

The company, which was founded in 2011, has a head office in Fujairah, an emirate on the east coast of the United Arab Emirates (UAE), and branch offices in Dubai, Qatar and Pakistan, provides quality, reliable services for customers in the electrical energy supply sector. In line with its partnership with Bender, the experts in electrical safety, Al Sanabel Technologies LLC aims to make electrical energy safer and more reliable.

Since the company was founded, Al Sanabel Technologies LLC has now built up a five-strong committed and capable team under the leadership of Mohammad Anwar Mirza.

As a Bender representative, the most important projects and events for Al Sanabel Technologies LLC have been in the hospital technology sector. In medical facilities, even a brief power failure can jeopardise successful diagnostics and treatment and therefore the health of the patient. So the requirements for power supply reliability are very exacting. Bender has a range of solutions in this area.

Numerous trade fair participations

At the “Arab Health” trade fair in Dubai, UAE, in January 2012, Al Sanabel acted as a Bender representative for the first time and advertised its hospital solutions. After an overwhelming response in the follow-up to “Arab Health”, Al Sanabel also attended the “Hospital Build and Infrastructure Exhibition” in Dubai in June 2012. At this fair, the team welcomed some 200 visitors from various sectors of hospital infrastructure to its stand.

In March 2015, Al Sanabel’s stand at “Middle East Electricity” in Dubai was visited by over 100 people from different countries.



Hospital Build Exhibition, June 2012

The trade fair participations successfully raised the profile of the representative agreement and Bender products in the United Arab Emirates.

IT system distribution boards for hospitals

Al Sanabel got its first big breakthrough in the year it was founded: the company was successful in an invitation to tender for the Sidra Medical & Research Center in Doha, Qatar, in August 2011 and won the contract for the delivery, installation, testing and commissioning of the supply systems for one of the largest projects of the Qatar Foundation. Al Sanabel supplied around 70 IT floor-mounted distribution boards.



Snapshot of the stand at Middle East Electricity, Dubai, March 2015



Welcome meal for the Bender team organised by Al Sanabel, March 2015



IT distribution board with insulation monitoring device isoMED427P

It went on to win a number of similar orders, including for the Al Jalila Children's Hospital in Dubai the Hammad Medical City, Doha, Qatar, the Tarwam Hospitals in the city of Al Ain, the NMC Hospital in Abu Dhabi, the Bin Omeir Hospital in Abu Dhabi, the Aster IVF and Women Clinic in Al Mankhool in the heart of Dubai and the Corniche Hospital, the largest maternity hospital in the UAE, to name just a few examples.

In early 2013, Al Sanabel was awarded the contract as the sole representative of Bender products in Pakistan. In March 2013, Al Sanabel provided the first IT system distribution board for two hospitals in Karachi, the Sindh Institute of Urology & Transplant and the Civil Hospital. This was followed in 2014 by a contract to provide Bender healthcare solutions to the Bahria Town Hospital in Lahore and Islamabad. Bahria Town is a residential building company with branches in various big cities in Pakistan. The hospitals in the Bahria Town complexes in Lahore and Islamabad are still under construction, but the operating theatres have already been kitted out with Bender systems.



AGENTS CORNER

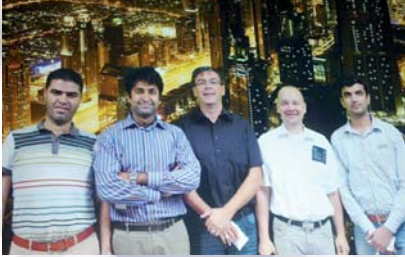

"At the top" of Burj Khalifa, Dubai, October 2012: The Bender team of Amin Shabou, Holger Podevin and Jürgen Fischer during their visit to the UAE. The Dubai Fountains, the biggest tourist attraction in the Middle East, are at the foot of what is currently the tallest building in the world



The AI Sanabel team with Amin Shabou in Lahore in May 2016

▶▶▶ Alarm indicator and operator panels

Bender's solutions for the healthcare sector include more than just IT system distribution boards. For example, AI Sanabel delivered a Bender surgical control panel (SCP) for the Abdullah Omran Hospital in Ras Al Khaimah in September 2013. The first panel of this kind was installed in Pakistan in October 2014. This is now in use by the largest charity cancer clinic in Pakistan, the Shaukat Khanum Memorial Hospital and Research Center in Lahore. Many further panels are to follow.

Not only active in the hospital sector

AI Sanabel was involved in the modernisation of the Upper Zakum offshore oil field in Abu Dhabi, UAE, one of the largest crude oil fields in the world. In May 2015, AI Sanabel supplied Bender products for insulation monitoring of ABB mains cables and insulation fault location systems (EDS).

AI Sanabel successfully entered the UAE aviation industry in April 2014. Since then, the Crisis Center for Etihad Airways, an airline based in Dubai, has been using Bender products for monitoring unearthed power supply systems (IT systems).

Lively exchange of information

Bender often invites its sales partners from all over the world to visit. The employees of AI Sanabel attended a practical training course to find out about the latest Bender products in October 2013. There was a meeting for EMEA representative in Oberusel in September 2015 (see Monitor 2/2015) which the AI Sanabel team also attended. Various business ideas were exchanged and project details discussed.

May 2016 was a big month for AI Sanabel, as the company welcomed Amin Shabou, the Bender Sales Manager for the MENA region in Lahore, Pakistan. It was the first visit of a Bender manager to Pakistan since AI Sanabel had been representing Bender in Pakistan. Amin Shabou visited the POGEE trade fair and took part in a company meal organised by AI Sanabel, to which they had also invited numerous guests from various companies, including representative of NESPAK, one of the largest consultancy companies in the country.

"We at AI Sanabel Technologies LLC are very proud to appear in MONITOR. The magazine provides useful information about the latest developments." ■



Mohammad Anwar Mirza, AI Sanabel
Dubai, United Arab Emirates



“Packages protect goods and keep their quality.”



Specialist for Better Packaging

MULTIVAC is one of the world's leading suppliers of packaging solutions: global market leader in thermoformers and manufacturer of an extensive range of traysealers, vacuum chamber machines, conveyor belt machines, labelers, quality control systems, and automation solutions, as well as turn-key packaging lines. ▶▶▶

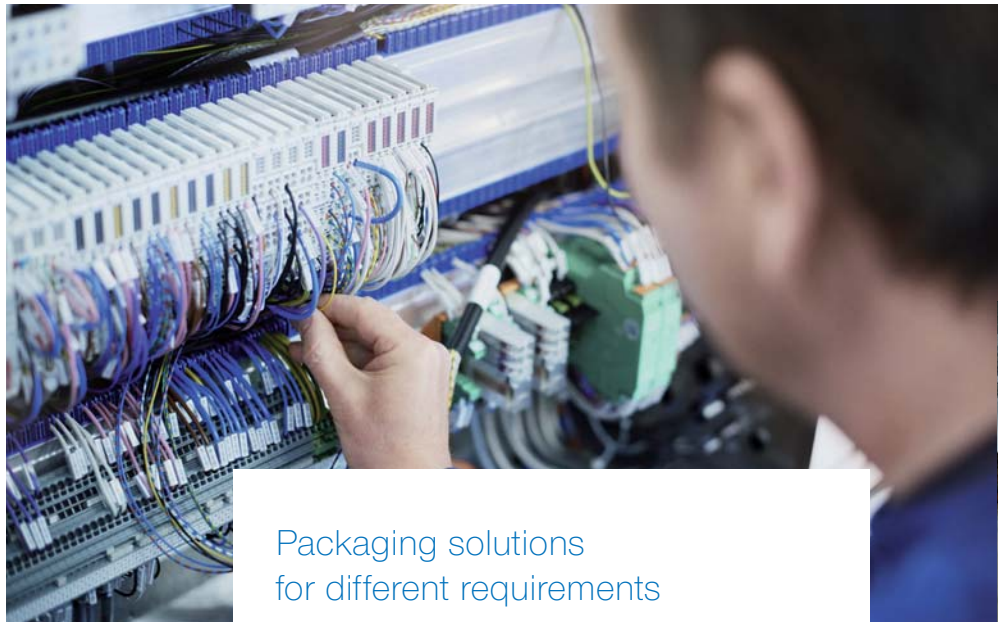

Packaging solutions for different requirements

MULTIVAC provides flexible and intelligently conceived solutions for all of these packaging requirements, designed specifically to meet the individual needs of a particular application. The systems have an open machine structure, into which new modules, for transportation or positioning for example, can easily be integrated. All components can be fully synchronized to prevent any loss of technical or economic efficiency. MULTIVAC also has a range of innovative handling modules oriented precisely to the positioning and transportation tasks within the packaging chain. In addition, MULTIVAC packaging solutions stand for secure, reliable processes, which are continuously monitored from start to finish, with visual inspection systems (Vision Systems), sensors, and operator-related recording of process parameters, and which comply with all applicable safety and hygiene standards.

Sustainability – ecological and economic

One factor which has a critical influence on the development of MULTIVAC packaging solutions is sustainability. Sustainability always comes from an

▶▶▶ **MULTIVAC packages** all types of food products, medical and pharmaceutical supplies and industrial goods, building on innovative, top-class technology, extensive product expertise, and many years of experience in the sector. In addition, customers benefit from the broad-based process and systems expertise of MULTIVAC specialists and from a comprehensive consultancy service, all from a single source.

Good packaging has to accomplish a variety of different tasks: its principal purpose is to protect the contents and ensure that the product reaches the end user safely. But that's not all. If it is aimed directly at the end user, the packaging also has to sell the product and fulfill a marketing role. In the food sector the packaging must keep the product fresh and extend its shelf life. For medical and pharmaceutical supplies, safety, sterility and clean-room compatibility are critical. The packaging must also ensure compliance with strict rules and regulations. And in the case of valuable or complex products, the packaging should also help to protect against counterfeiting.



"MULTIVAC provides **flexible and intelligently conceived solutions** for all packaging requirements."



Thermoforming Packaging Machine R 245



Traysealer T 850

optimal combination of ecological and economic considerations. MULTIVAC takes care of both aspects: for instance, it encourages the use of biodegradable materials, such as biopolymer films, and carries out regular tests on new, eco-friendly packaging films.

In addition, by offering intelligent methods of integrating individual machines into larger systems, MULTIVAC can make an important contribution to economic sustainability and hence to affordable overall costs. MULTIVAC also contributes to greater sustainability simply through the use of film packaging products. Without this type of packaging, many products – such

as perishable foods or medical and pharmaceutical supplies which have to meet special cleanliness requirements – could not be used at all.

The MULTIVAC Group employs more than 4 700 people worldwide, with around 1 750 employees based at its headquarters in Wolfertschwenden, Germany. With over 75 subsidiaries, the company has a presence on every continent. Over 1 000 advisors and service technicians worldwide use their expertise and experience in the service of customers and ensure the maximum availability of all installed MULTIVAC machines. ■

Seminar

NEWSWORTHY +++ SEMINAR ANNOUNCEMENT +++

SPECIALIST
CONFERENCE

29. - 30.11.2016

Munich Airport

Electrical systems at airports

The operation of airports sets high standards in terms of electrical safety and reliability.



TÜV Süd in conjunction with Bender GmbH & Co. KG is offering a two-day seminar in Munich on this subject in November 2016.

It will cover current operational requirements and safety problems and solutions for measurement and operation of electrical systems at airports. The specialist conference is aimed at the operators of civil and military airports and the manufacturers of aviation lighting systems in Germany and its neighbouring countries.

Operators, planners and TÜV Süd experts will present established strategies for operation, maintenance and servicing and highlight suitable safety measures. The programme will include practical presentation on subjects such as 400 Hz systems, safe electricity and emergency electricity supply, safety of people, operational safety, aviation lighting technology and current standards. The first day of the conference will also feature an excursion led by experts to Munich Airport with a viewing of various electrical systems. At the same time, participants will have opportunity for discussion and in-depth exchange of ideas.

The specialist conference on **“Electrical systems at airports safety in the design and operation”** will take place on **29 and 30 November 2016.**

It will be held at the MUNICON Conference Centre at Munich Airport.

More information on this event, the conference programme and enrolment options can be found at www.tuev-sued.de/akademie-de/congress/netz-technik-funktionale-sicherheit/flughafenbetrieb

Secure your place at the specialist conference. If you have any questions, please do not hesitate to contact the team at TÜV Süd academy. ■

Marita Schwarz-Bierbach
S-COM

CONTACT:

TÜV SÜD Akademie GmbH
Seminars and conferences

Viktorija Wolter

Tel: +49 89 5791-2410, Fax: +49 89 5155-2468

Mail: congress@tuev-sued.de



EXHIBITIONS 2017



EXHIBITIONS INTERNATIONAL

OSEA 2016

**International Oil and Gas Industry
Exhibition & Conference**

29.11. – 02.12.2016

Location: Marina Bay Sands (Singapore)



Middle East Electricity – Energising the Industry

11. – 13.03.2017

Location: Mumbai, India



ELEKTRO 2017

17. – 20.04.2017

Location: Moscow (Russia)



8th Annual National Electric Mobility Canada

Conference and Trade Show (EV2017)

29.05. – 01.06.2017

Location: Markham, Ontario (Canada)



Electric Hybrid Marine

06. – 08.06.2017

Location: Amsterdam (Netherlands)



EXHIBITIONS NATIONAL

SPS IPC Drives 2016

22. – 24.11.2016

Nuremberg



Fachschulung für Gebäudetechnik

24. – 26.01.2017

Rostock



Elektrotechnik

15. – 17.02.2017

Dortmund



eltefa

29. – 31.03.2017

Stuttgart



Hannover Messe

24. – 28.04.2017

Hanover



Wümek

**Interdisziplinäre Kongress
für Technik und Hygiene im
Krankenhaus**

03. – 04.05.2017

Wuerzburg



Intersolar

31.05. – 02.06.2017

Munich



MEORGA – MSR-Spezialmessen

14.06.2017

Hamburg





Peter Eckert

Market Segment Manager Critical Infrastructure at Bender

CAREER OUTLINE

Peter Eckert, born 1971, grew up and lives in Lower Bavaria near Landshut. After his training as a communication electronics technician with the Deutsche Bahn in Munich and further training to become a certified industrial foreman for electrical/communications engineering, he worked for eight years as an engineer and site manager for IT systems. From 1999 to 2001 he worked in an internal sales team and on portfolio management in the electrical wholesale trade, from 2001 to 2011 in various sales positions in the internal sales team and project management at Emerson Network Power, including four years as product manager for monitoring systems, and from 2011 to 2015 as consultant for power and software solutions at Raritan. Since March 2015 he has been employed as Market Segment Manager for the "Critical Infrastructure" area at Bender.

Availability and uninterrupted operation in the server room

Herr Eckert, what matters to an organisation that operates a computer centre?

The primary goals of all facility managers in computer centres, server parks and IT rooms are high performance, availability and the optimal usage of resources. To provide this high availability and electrical safety at the same time, operating organisations use complex electrical power supply systems and components. The critical aspects here: failures, malfunctions or interruptions during operation signify effort, costs and the loss of safety. If these occur due to avoidable faults, the effects are all the greater. Therefore the high availability of the power supply for IT installations must be ensured above all else.

Which requirements are placed on data centres these days?

Personal, operational and installation safety, the highest availability and cost-effectiveness are a must these days and require a trouble-free, fail-safe supply of electrical power. Any failure may cause significant

costs. The continuous monitoring of the electrical power supply, above all critical parameters such as temperature, atmospheric humidity, dew point, fire, movement etc. therefore form part of the basic features of a modern computer centre. Only in this way can malfunctions or faults be detected in good time and averted. The causes are mostly insulation faults, stray currents, overloads on N conductors due to harmonics, or open circuits in PE and N conductors.

What protection options are there?

To be able to ensure trouble-free operation, organisations operating installations must comply with the protection requirements in the German ordinance on industrial health and safety (BetrSichV) and the accident prevention regulations for electrical installations and equipment (periodic verification). These require periodic verification to ensure the electrical equipment is fault-free. This is only possible with permanent network monitoring and

"Why extinguish a fire if you can avoid it starting?"

analysis. By using residual current monitors (RCM), changes in the level of the insulation in a power supply can be detected at an early stage before a hazardous fault current with a risk of fire causes protective devices to trip. It is necessary to go more and more into the detail and also to measure and evaluate fault currents, equalising currents and insulation faults in a finely structured manner. This task is undertaken by current and energy measuring systems that make possible the safe operation of the electrical supply in accordance with the standards. The risk of fire, interruptions in operation, malfunctions, damage, data loss due to faulty electrical insulation or due to EMC effects, as well as hazards for people in computer centres are avoided.

Which challenges must you face as Market Segment Manager in the data centre sector for Bender?

Our technology is not directly required to ensure the operation of a computer centre. In the same way that an extinguishing system is not required as long as there is no fire. However, our technology offers an additional benefit for the operating organisation that has real monetary value. I show operating organisations how they can use our technology appropriately so they can operate better their core business. For this reason I am often away at trade fairs, symposiums, meetings held by associations, at exhibitions and give presentations. As the link between the market and Bender, I also obtain information on trends, maintain contacts with decision-makers and am a generator of inputs. Together with our specialists, I clarify how technical requirements can be implemented in general and in the specific case, and what is necessary or only "nice to have" or even appropriate. During this process a close eye is kept on the effects of regulations and laws on our prospects on the market.

The currently applicable standards and regulations must always be met, in particular the new computer centre standard EN 50600. Within the company I provide sales support to projects and act as the link between the market segment, product management and marketing.

In your opinion what are Bender's greatest advantages in this sector?

The main focus for computer centres is on IT systems such as servers and storage hardware and their applications. In addition there are also the infrastructure components such as cooling and UPS systems. By monitoring the entire power supply chain, we ensure there is more availability, improved operational safety due to the early detection of a possible critical system status, as well as comprehensive protection of persons and installations against hazards caused by electrical power.

In a computer centre it is not possible to shut down simply using e.g. a residual current circuit breaker, because in the ideal case you never shut down in the computer centre. However there are people in the computer who are often not electricians. These persons must be protected against electric shock just like in any other electrical installation. This is stipulated not only by the standard, but also by common sense. With our RCM technology we offer a suitable solution: protection of personnel without disconnection.

Other key points are improved cost-effectiveness due to the avoidance of unplanned system shutdowns, reduction of the time and personnel required for maintenance, detection of weak spots in systems and support to investment decisions. Every major computer centre has a fire-extinguishing system. The number one cause of fire, the insulation fault, can be detected and rectified in good time with RCM technology. Why extinguish a fire if you can avoid it starting? The trouble-free supply of electrical power and therefore uninterrupted operation is a basic prerequisite for the safety of man and machine. ■

Herr Eckert, thank you for this informative interview.

Michaela Heck M.A., textwerk-heck

Practical Expertise

Page A

Bender system communication

The communication in a Bender system is versatile. Here a large number of different protocols are combined into "one large system".

At Bender it was recognised at an early stage that good communication between the devices is very important. For this reason at the start of the 90s the RS-485 based BMS (Bender-Messgeräte-Schnittstelle or Bender measuring device interface in English) protocol was developed. With this protocol devices could communicate with each other. Measured values, parameters and alarm messages were exchanged, and in this way it was possible to react to events in the system. Having access to this wide range of data from all the parts of the installation is essential for safe operation.

Today's systems

In the system landscape these days it is imperative countless interfaces and protocols are combined. In

its COMTRAXX[®] condition monitors, Bender combines not only its own interfaces BMS and BCOM, but also PROFIBUS DP, Modbus RTU, Modbus TCP and SNMP. The devices in the COMTRAXX[®] series are therefore used as data collectors and control centres for the Bender system and also make all data available to other systems via interfaces. The POWERSCOUT[®] solution also became available recently; using this solution it is now possible to save all data from the installation and to analyse them in a web-based solution. It is also possible to condense data into a report e.g. for periodic verification, (on this topic see: powerscout.bender.de).



A current system from today's point of view

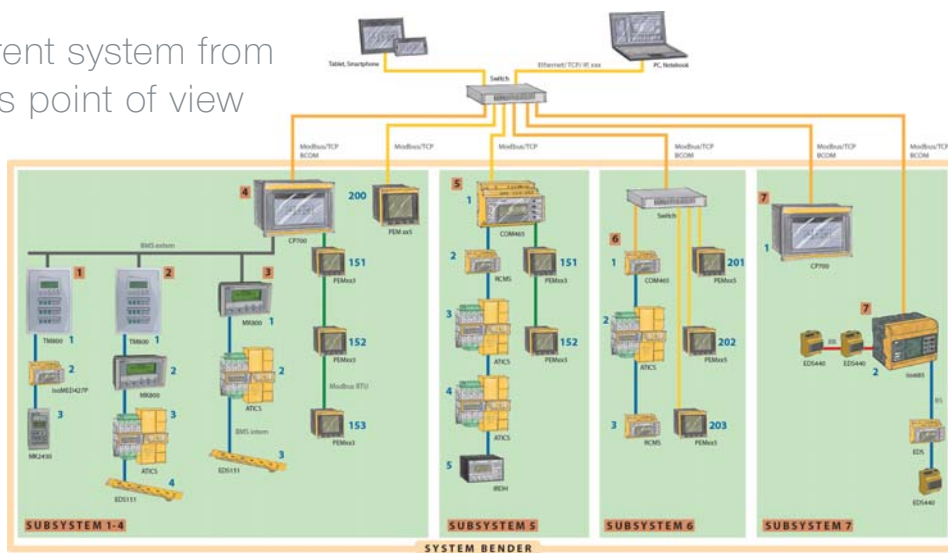

Practical Expertise

►►► The BMS bus

What you need to consider on planning, installing and configuring a properly working system is explained in the following.

The BMS bus transmits alarms and operating messages cyclically. It is possible to query and change device parameters as well as to send various control commands. The bus operates on the MASTER-SLAVE principle. It is also possible to create INTERNAL and EXTERNAL bus segments. The INTERNAL bus is used at device level, the EXTERNAL bus to connect systems together. The INTERNAL baud rate is

BMS bus structure

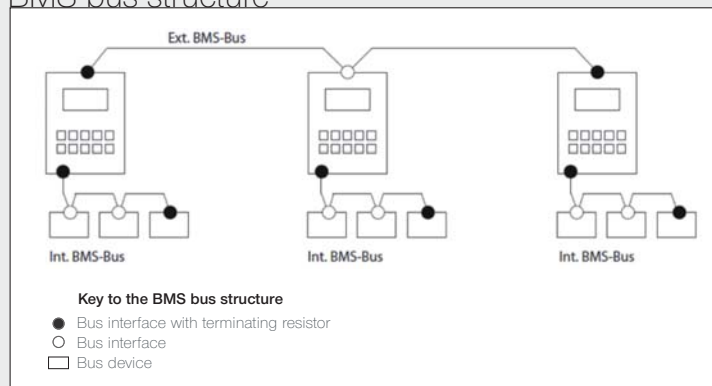

9,600 baud, on the EXTERNAL bus it can be set to 19,200, 38,400 or 57,600 baud. ■

Jan Hofmann T-SCT-PM

The 10 "golden" BMS rules



01. Each bus segment (internal and external) must be controlled by a MASTER.
02. There is only allowed to be one MASTER in each bus segment.
03. The MASTER always has the address 1.
04. Each slave has a sequential address, starting with the address 2. The address gap between two slave devices is not allowed to be greater than three addresses.
05. There must not be any duplicate addresses in a bus segment.
06. The bus topology (line) must be taken into account during installation.
07. A bus segment must be terminated at both ends with a bus terminating resistor (120 Ohm). Many devices have a resistor that can be enabled for this purpose.
08. A bus segment is not allowed to exceed a maximum length of 1,200 m. RS-485 amplifiers (e.g. DI-1DL) are required for longer cable lengths.
09. The maximum number of devices per bus segment should not exceed 32. RS-485 amplifiers (e.g. DI-1DL) are required for larger systems. Bias generation and bus terminating resistors must be taken into account.
10. The data cable must be a screened, twisted pair cable (e.g. J-Y(St)Y nx2x0.8). The screen must be earthed at one end.

BENDER Group

The Bender Group with its main office in Gruenberg/Hesse has 70 representations and 14 subsidiaries with nearly 700 employees worldwide.

You can find your regional contacts at www.bender.de.



Bender GmbH & Co. KG
Londorfer Str. 65 • D-35305 Gruenberg / Germany
Fon: +49 6401 807-0 • Fax: +49 6401 807-259
E-Mail: info@bender.de • www.bender.de



BENDER Group

Power in Electrical Safety